

Mounting Kit 53366

Dodge 1500 4x4 2009-2018

Dodge 1500 2019-2021 Classic Style

Personal Use Only

For the snowplow lights (2009-2012), this kit requires:

800084 or 800086 light kit,
53617-M wiring kit
800034 light adapter for H13 vehicle's bulb

For the snowplow lights (2013-2019), this kit requires:

800084 or 800086 light kit,
53618-M wiring kit
800034-MPX light adapter for HB3/H11 bulb
800105-MPX light adapter for HB3/HIR2 bulb

Note: This vehicle, as received from the manufacturer, has a very low ride height. Suspension modifications may be required to achieve enough ground clearance to install a snowplow.

Note: All holes in the vehicle frame are to be drilled

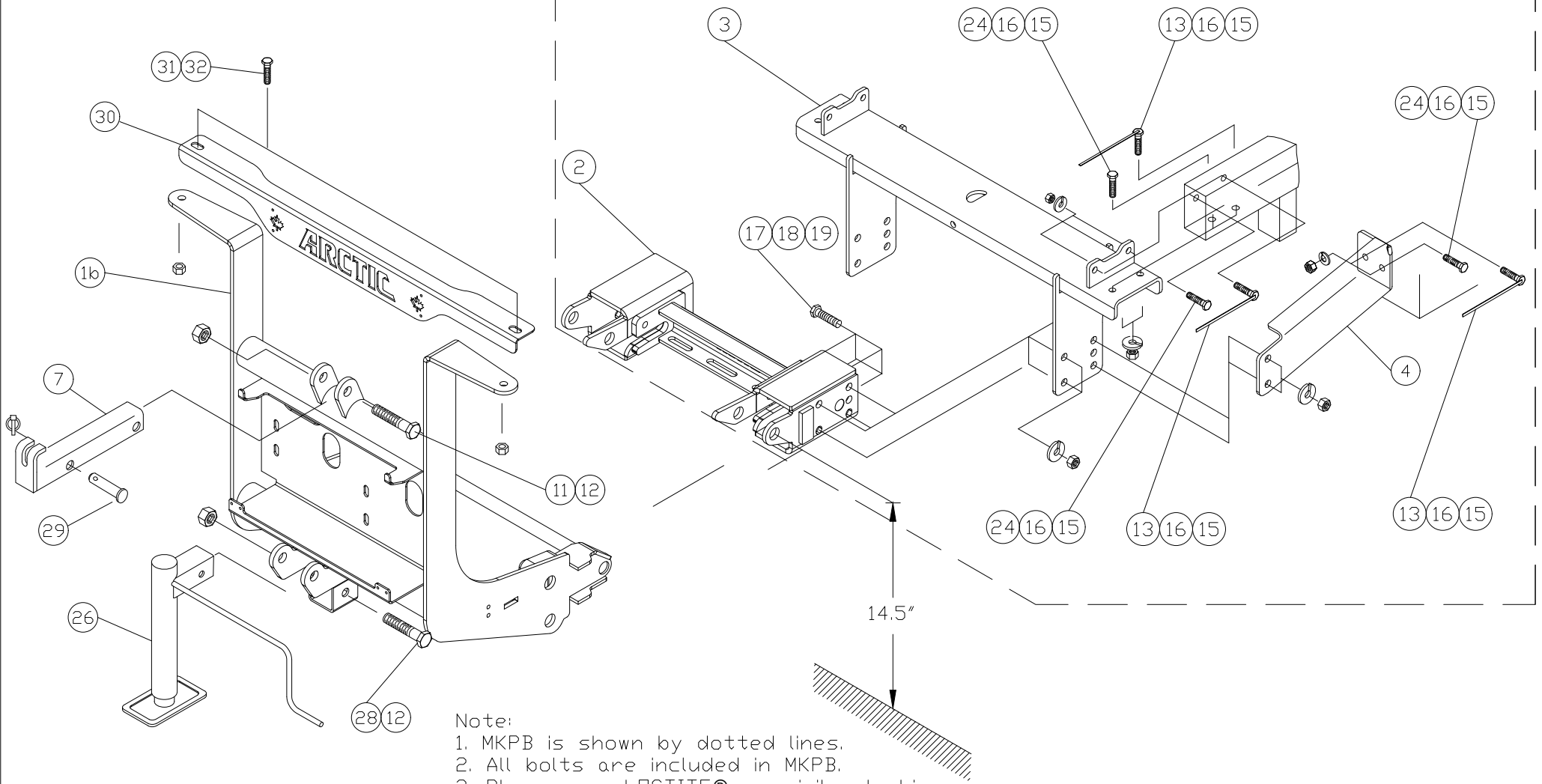

Note:

1. MKPB is shown by dotted lines.
2. All bolts are included in MKPB.
3. Please use LOCTITE®, or similar locking product on ALL mounting hardware (bolts, nuts, etc.).

Item	Part #	Description	Quantity
1*	53170-D-GA	Lift Frame, QUIK*LINK ® II- low mount	1
1a*	53564-D	Lift Frame, QUIK*LINK ® IV-low mount	1
1b	53853-HANDLE	SD2 Lift frame c/w Handle	1
2	53551-C	Spreader bar QLIV	1
3	53367-C	Mounting Bracket	1
4	53370-01-B	Thrust Arm Driver Side	1
5*	53370-02-B	Thrust Arm Curb Side	1
7	50069-C-GA	Lift Channel (1 ½" cylinder)	1
7a*	52612-C-GA	Lift Channel (2" cylinder)	1
8	52209-B-GA	Light Antler	1
9	52208-B-GA	Light Bracer	2
10	HH-00972-149	3/4" x 2½" UNF Cap screw	1
11	HH-00972-153	3/4" x 3½" UNF Cap screw	1
12	HH-00973-007	3/4" UNF Thin Collar Lock nut	3
13	52575-A	½" bolt with 6" welded handle	6
14	HH-00972-090	1/2-20x1.1/2 UNF Cap screw	6
15	HH-00460-002	1/2-20 Hex nut	18
16	HH-00457-001	1/2 Lock washer	18
17	HH-00972-130	5/8-18 x 2 UNF Cap screw	8
18	HH-00457-003	5/8 Lock washer	8
19	HH-00460-001	5/8-18 Hex nut	8
20*	HH-00293-006	1/4" x 1" Cap screw	4
21*	HH-00457-006	1/4" Lock washer	4

Item	Part #	Description	Quantity
22*	HH-00341-002	1/4" Flat washer	4
23*	HH-00294-001	1/4" Hex nut	4
24	HH-00972-091	1/2-20x1 3/4 UNF Cap screw	6
25*	WA-34704-M	Mounting Pin, QLI Ass'y	2
26	52373-M	Jack Assembly	1
27*	50999-B	Blade guides	2
28	HH-00972-155	3/4" x 4" UNF Hex Head Cap screw	1
29	52757-M	Lift Channel Pin Assy	1
30	53858-04-M	Arctic Logo Plate c/w backing plate	1
31	HH-00971-105	7/16 -14 x 1 1/4" Carriage bolt G5	2
32	HH-00340-002	7/16-14 Nylon Insert Lock nut	2
33*	53366-M-WB	53366 Bolt Bag c/w welded bolts	

QUIK*LINK is a trademark of Arctic Equipment Manufacturing Corporation
Note: * These items are not shown on the drawing.

GENERAL INFORMATION

Customer must be aware of following:

Arctic Equipment Manufacturing Corporation (Arctic) does not assume liability for damage to your motor vehicle resulting from the attachment or use of an Arctic snowplow. The purchaser assumes all vehicle risk associated with the attachment and operation of this snowplow.

The Arctic snowplow you purchase must be used only on vehicles equipped with the manufacturer's snow plow preparation package. Snow plowing without the original plow preparation package may damage your vehicle. The added weight may impair the operation and control of your vehicle. Snow plowing with a vehicle not recommended for that purpose by the manufacturer may void your new vehicle warranty. If your vehicle is not equipped with an original snow plow preparation package, additional equipment may be necessary before snow plowing. Please consult your vehicle and snowplow dealers prior to the purchase and installation of the snowplow. The installation of such parts however is not a full substitute for the original equipment snowplow preparation package.

Before drilling any holes in the firewall or frame, move brake lines, fuel lines and/or electrical wiring from the path of the drill. Brake and fuel lines must also be clear of any fasteners.

All bolts should be installed from the inside of the truck frame so that the lock washers and nuts are accessible for re-tightening.

If a slotted hole in the truck frame is utilized, then a flat washer must be used under the bolt head Please use LOCTITE®, or similar locking product on ALL mounting hardware (bolts, nuts, etc.).

Do not tighten any bolt assemblies until all fasteners and components are installed, unless otherwise specified.

After first use, re-tighten all mounting bolts, thereafter, check mounting bolt tightness periodically.

Before proceeding, read instructions carefully and familiarize yourself with the components and hardware.

INSTALLATION INSTRUCTIONS

1. Remove the bottom splash pan and tow hooks. Also remove bumper. After installation of mounting kit reinstall bumper and return splash pan, tow hooks and truck hardware to customer.
2. Slide mounting bracket (3) against vehicle frame. Assure that thrust arms (4)(5) sit against the truck cross member and line up with two holes in the mounting bracket (3). Using existing holes in the mounting bracket (3) drill 17/32" holes in the vehicle frame (four holes per vehicle side) and also using existing holes in the thrust arms (4)(5) drill 17/32" hole in the vehicle cross member (two holes per vehicle side). After drilling install ½" welded bolts (13), ½" bolts (24) and secure using ½" lock washers (16) and ½" hex nuts (15). Do not tighten any hardware until instructed to do so.
3. Insert the spreader bar (2b) between mounting bracket side plates. Insert 5/8" x 2 " bolts (17) from inside spreader bar (2) through mounting bracket holes and secure using 5/8" lock washer (18) and 5/8" nuts (19).

Note: Please use LOCTITE®, or similar locking product on ALL mounting hardware (bolts, nuts, etc.).

4. Torque all fasteners according to torque chart.
5. Slide lift frame (1b) inside of spreader bar (2b).
6. Install lift channel (7) and front mount power unit (from hydraulic kit) using 3/4" x 3½" bolts (11) and 3/4" locknuts (12). Use 3/4" x 2½" bolt (10) and 3/4" lock nut (12) to attach lift channel (7) to front mount power unit.
7. Use 1/4"x1" bolt (20), 1/4" flat washer (21), 1/4" lock washer (22) and 1/4" hex nut (23) to fasten blade guides (27) to blade.
8. Return any unused items to the customer so that the vehicle can be returned to its original condition if the snowplow is removed.
9. See separate installation instructions for the hydraulic power unit, wiring and controls.

Torque Chart (Ft. Lb)		
Size	Grade 5 Bolt	Grade 8 Bolt
¼ - 28	8	11
5/16 - 24	15	22
3/8 - 24	28	40
7/16 - 20	44	63
½ - 20	69	97
5/8 - 18	138	195
¾ - 16	241	341

Note: Torque values are for plated bolts only.