

MPX troubleshooting flowchart

(Except Dodge 2500/3500/4500/5500)

Underhood Installation

(module installed under the vehicle's hood)

For troubleshooting on Dodge trucks

click here

Important Note:

- **Use Power Probe III tool to troubleshoot the MPX system.**
- <https://www.youtube.com/watch?v=FuzfCOIA1Vw> – Link for Power Probe III tool instructions
- Update the modular box by updating tool (53707-N) if it was installed before 2017.
- See last page for more information on updating the modular box.
- See second page for more information on the Underhood Troubleshooting tool.

53706-M (Underhood Troubleshooting tool kit)

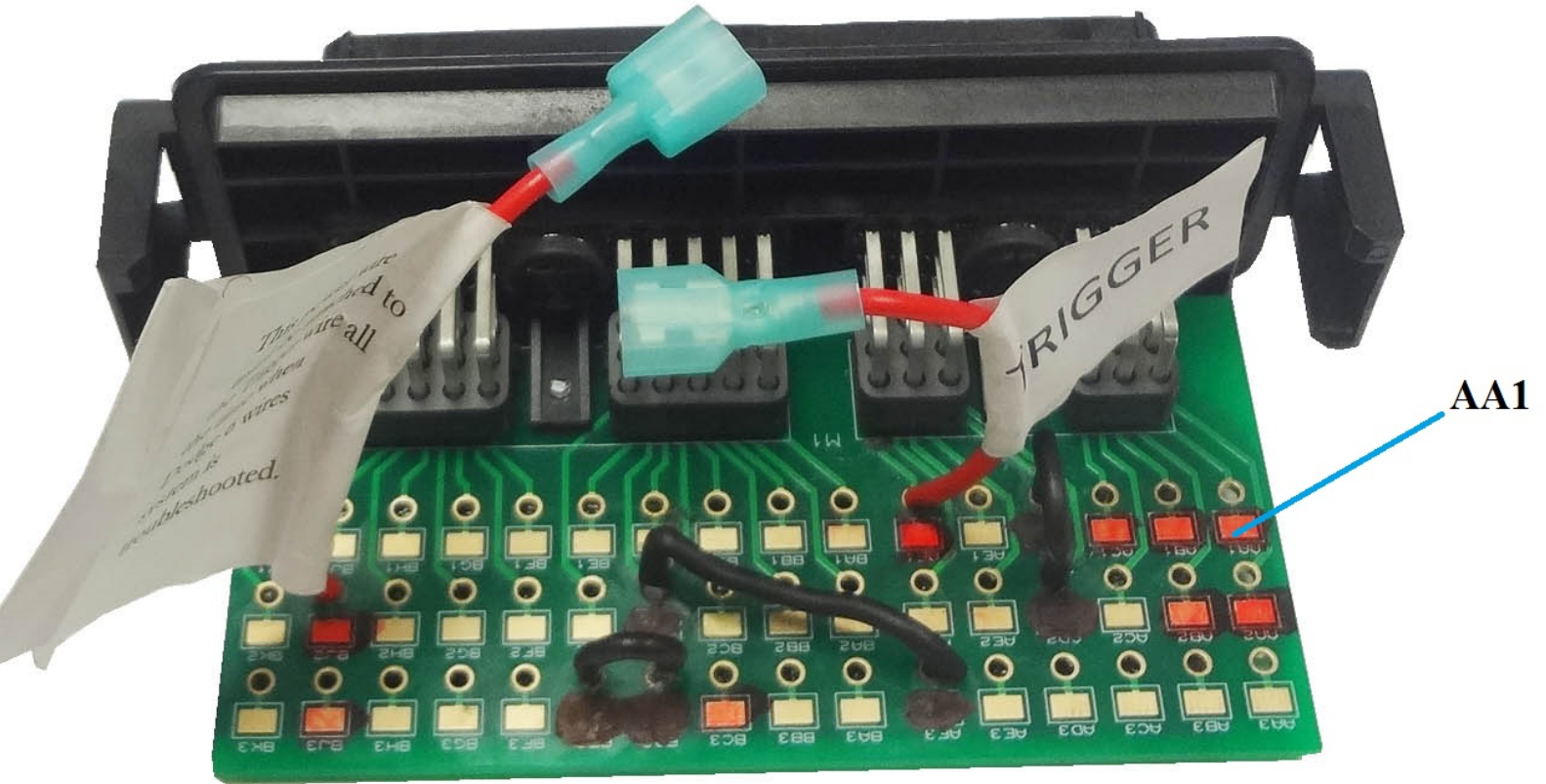

Terminal on the tool	Functions of the terminal
AA1	High Beam
AA2	Low Beam
AB1	Driver Side Turn
AB2	Driver Side Park
AC1	Curb Side Turn
AF1	Trigger
BC3	Ignition
BJ2	Power wire (Battery connection)
BJ3	Power wire (Battery connection)
BK1	Solenoid (Brown wire)

Note: Terminal Marked with Black color are Grounds.

Click on the link below to refer to the specific troubleshooting step:

- Marker/Position lights on one side of plow headlights is not working.
- Marker/Position lights on both the sides of plow headlights are not working
- High beam / Low beam on one side of the plow headlight is not working.
- High beam on both the sides of plow headlights are not working.
- Low beam on both the sides of plow headlights are not working.
- Turn Signal on Driver side of the plow headlight is not working.
- Turn Signal on Curb side of the plow headlight is not working.
- Plow does not operate and lights on the plow are not working.
- Plow does not operate.
- Lights do not transfer to the plow.
- Lights on the truck and the plow work at the same time.
- Individual functions on the plow are not working.
- Controller lights keep on changing.

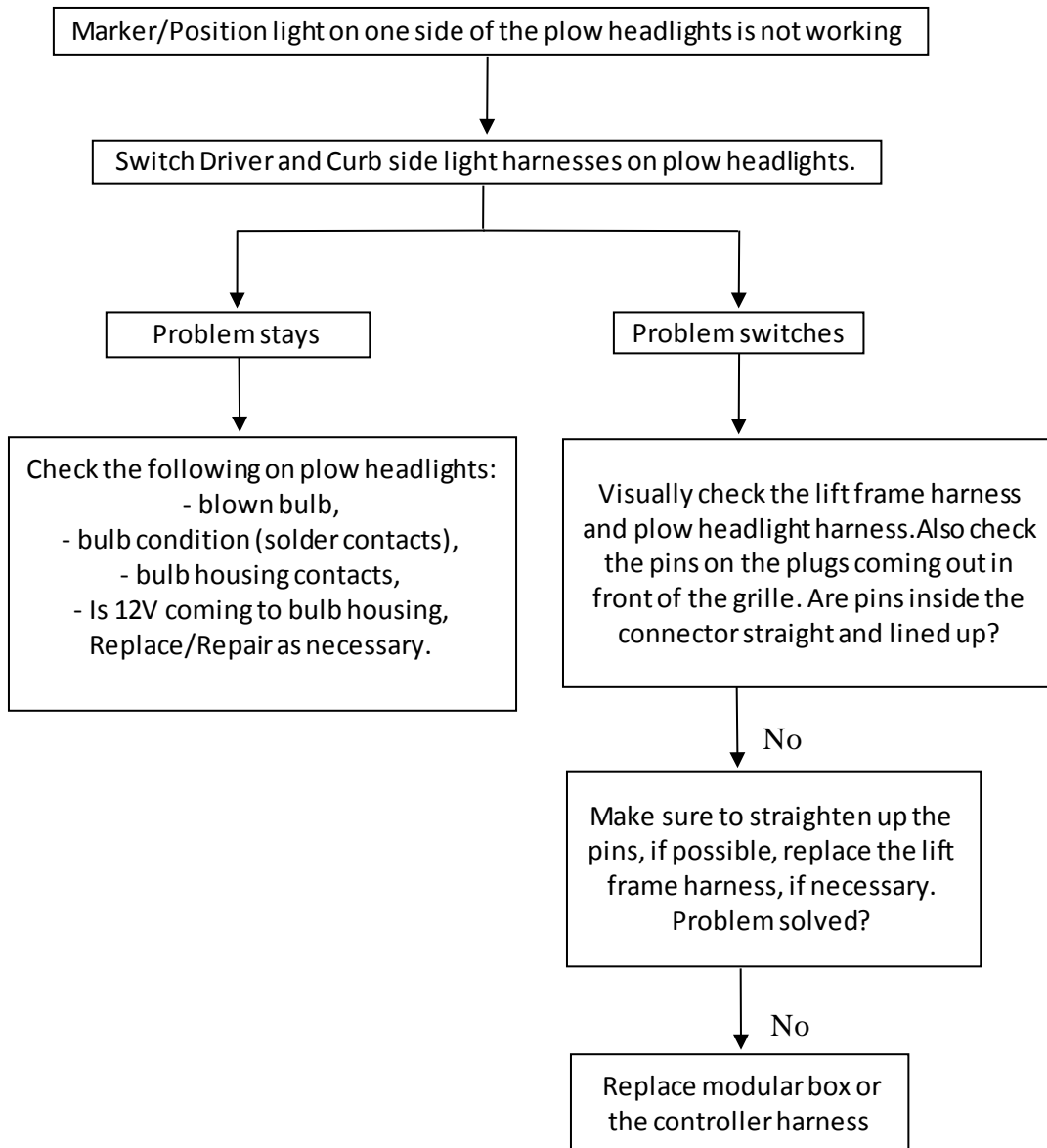

Restart truck's ignition after every step of troubleshooting.

Click on <https://www.youtube.com/watch?v=ErBX0E5GpeE&feature=youtu.be> to watch the video of this specific troubleshooting step.

Link for 800084 headlights: <https://www.youtube.com/watch?v=LJlgbdwop8Q>

Link for 800085 headlights: <https://www.youtube.com/watch?v=fn09WLSG-vI>

Link for 800086 headlights: <https://www.youtube.com/watch?v=sA7AxDIYgwc>

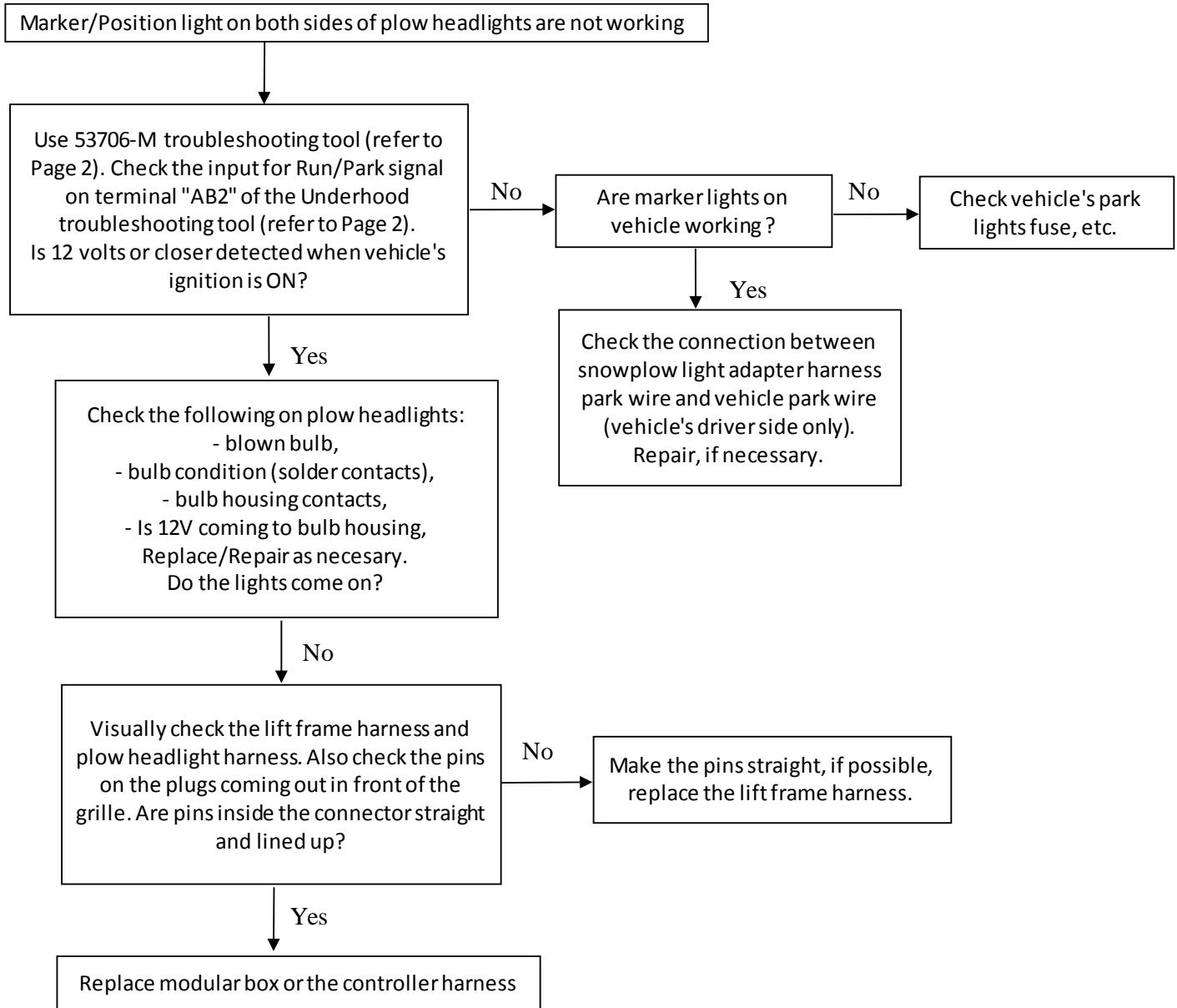

Restart truck's ignition after every step of troubleshooting.

Click on the link <https://www.youtube.com/watch?v=tZLjjQy-CIM&feature=youtu.be> & <https://www.youtube.com/watch?v=NIscF9wFpF4> to watch the video of this specific troubleshooting step.

Link for 800084 headlights: <https://www.youtube.com/watch?v=LJlgbdwop8Q>

Link for 800085 headlights: <https://www.youtube.com/watch?v=fn09WLSG-vI>

Link for 800086 headlights: <https://www.youtube.com/watch?v=sA7AxDIYgwc>

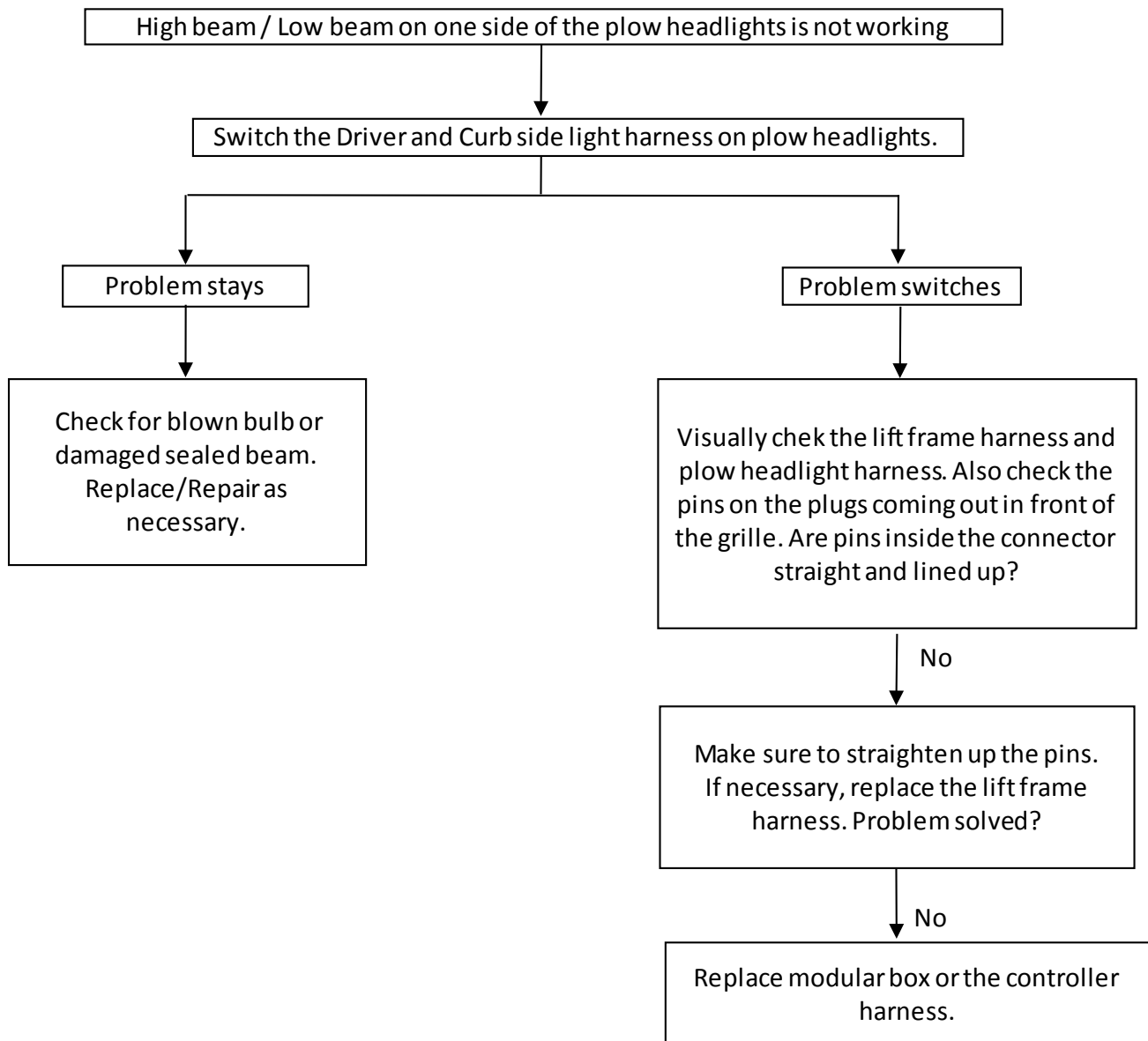

Restart truck's ignition after every step of troubleshooting.

Click on link <https://www.youtube.com/watch?v=7wruoLUVfdI&feature=youtu.be> to watch the video of this specific troubleshooting step.

Link for 800084 headlights: <https://www.youtube.com/watch?v=LJlgbdwop8Q>

Link for 800085 headlights: <https://www.youtube.com/watch?v=fn09WLSG-vI>

Link for 800086 headlights: <https://www.youtube.com/watch?v=sA7AxDIYgwc>

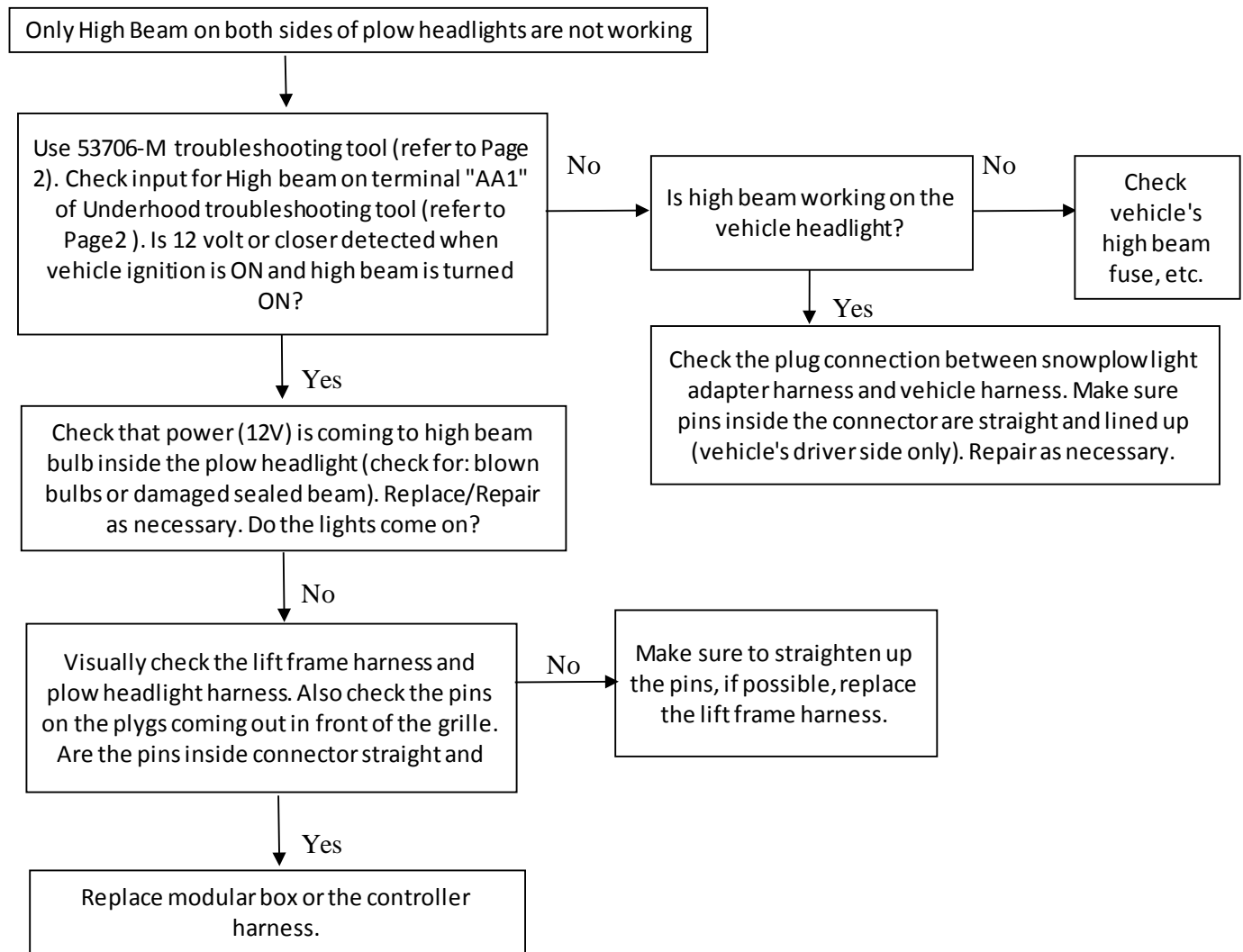

Restart truck's ignition after every step of troubleshooting.

Click on the link <https://www.youtube.com/watch?v=tZLjjQy-CIM&feature=youtu.be> & <https://www.youtube.com/watch?v=kHUj6SLcnVQ> to watch the video of this specific troubleshooting step.

Link for 800084 headlights: <https://www.youtube.com/watch?v=LJlgbdwop8Q>

Link for 800085 headlights: <https://www.youtube.com/watch?v=fn09WLSG-vI>

Link for 800086 headlights: <https://www.youtube.com/watch?v=sA7AxDIYgwc>

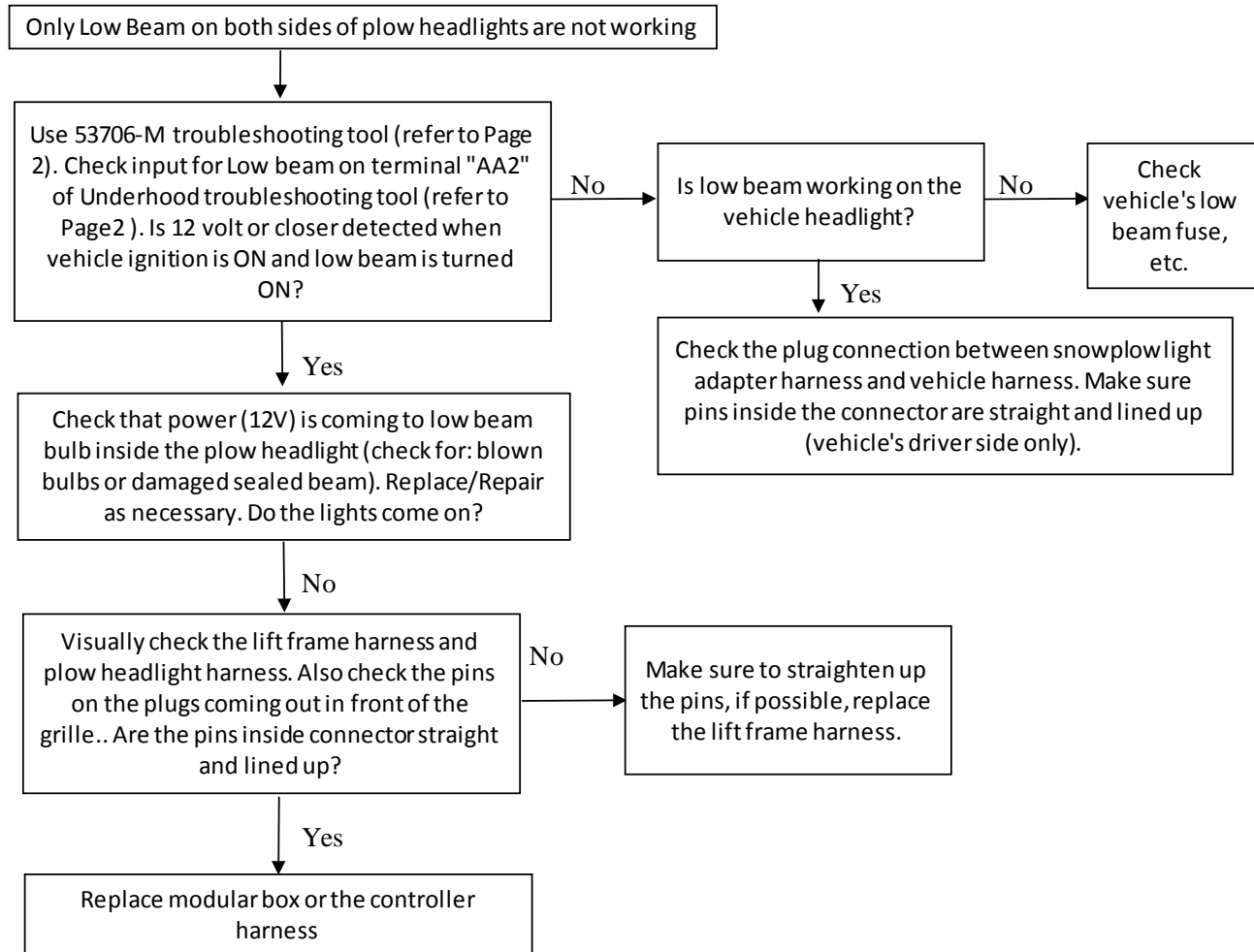

Restart truck's ignition after every step of troubleshooting.

Click on the link <https://www.youtube.com/watch?v=tZLjjQy-CIM&feature=youtu.be> & <https://www.youtube.com/watch?v=MqjS8OuLRR0> to watch the video of this specific troubleshooting step.

Link for 800084 headlights: <https://www.youtube.com/watch?v=LJlgbdwop8Q>

Link for 800085 headlights: <https://www.youtube.com/watch?v=fn09WLSG-vI>

Link for 800086 headlights: <https://www.youtube.com/watch?v=sA7AxDIYgwc>

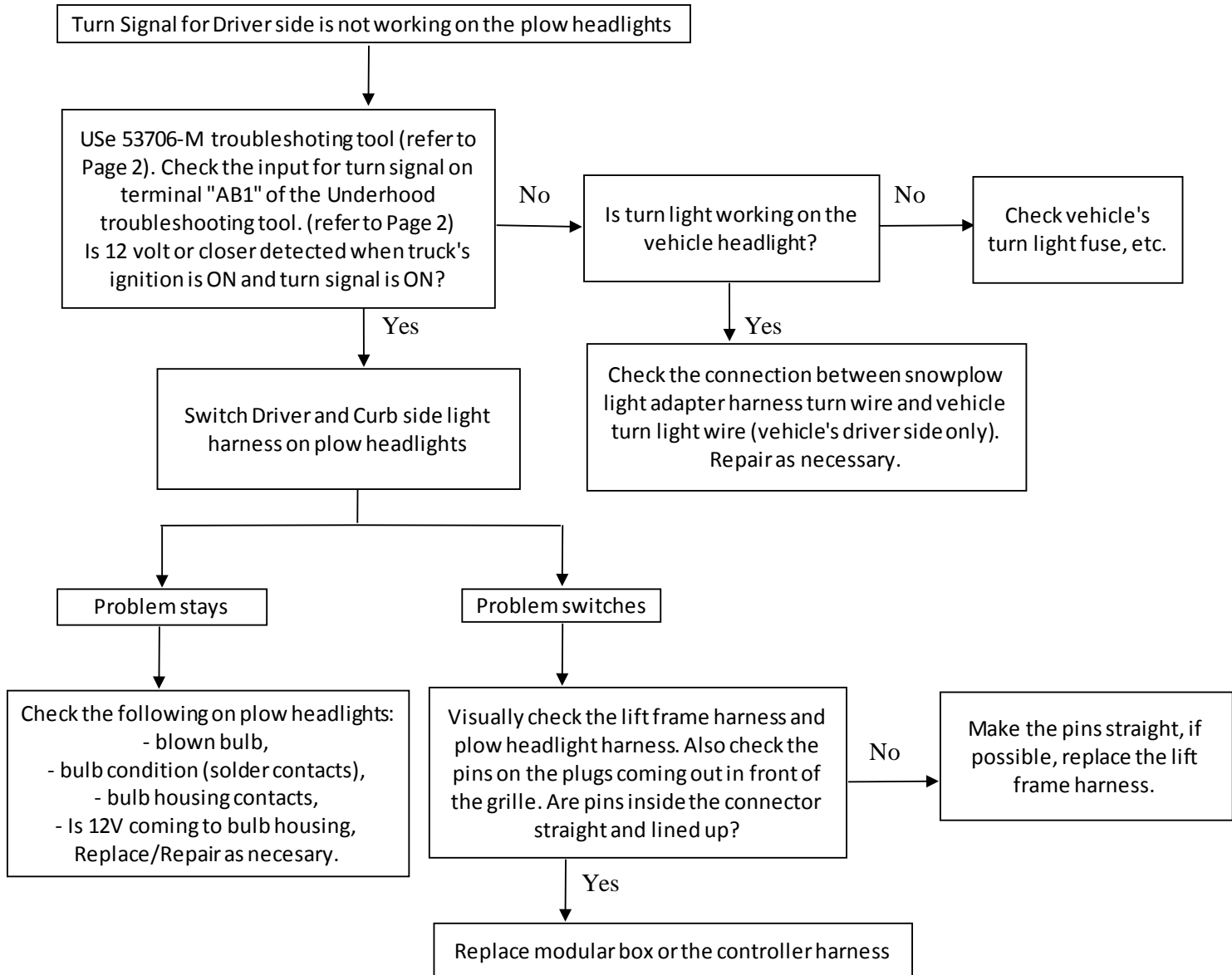

Restart truck's ignition after every step of troubleshooting.

Click on the link <https://www.youtube.com/watch?v=tZLjjQy-CIM> & <https://www.youtube.com/watch?v=xOVB7r3Sww0> to watch the video of this specific troubleshooting step.

Link for 800084 headlights: <https://www.youtube.com/watch?v=LJlgbdwop8Q>

Link for 800085 headlights: <https://www.youtube.com/watch?v=fn09WLSG-vI>

Link for 800086 headlights: <https://www.youtube.com/watch?v=sA7AxDIYgwc>

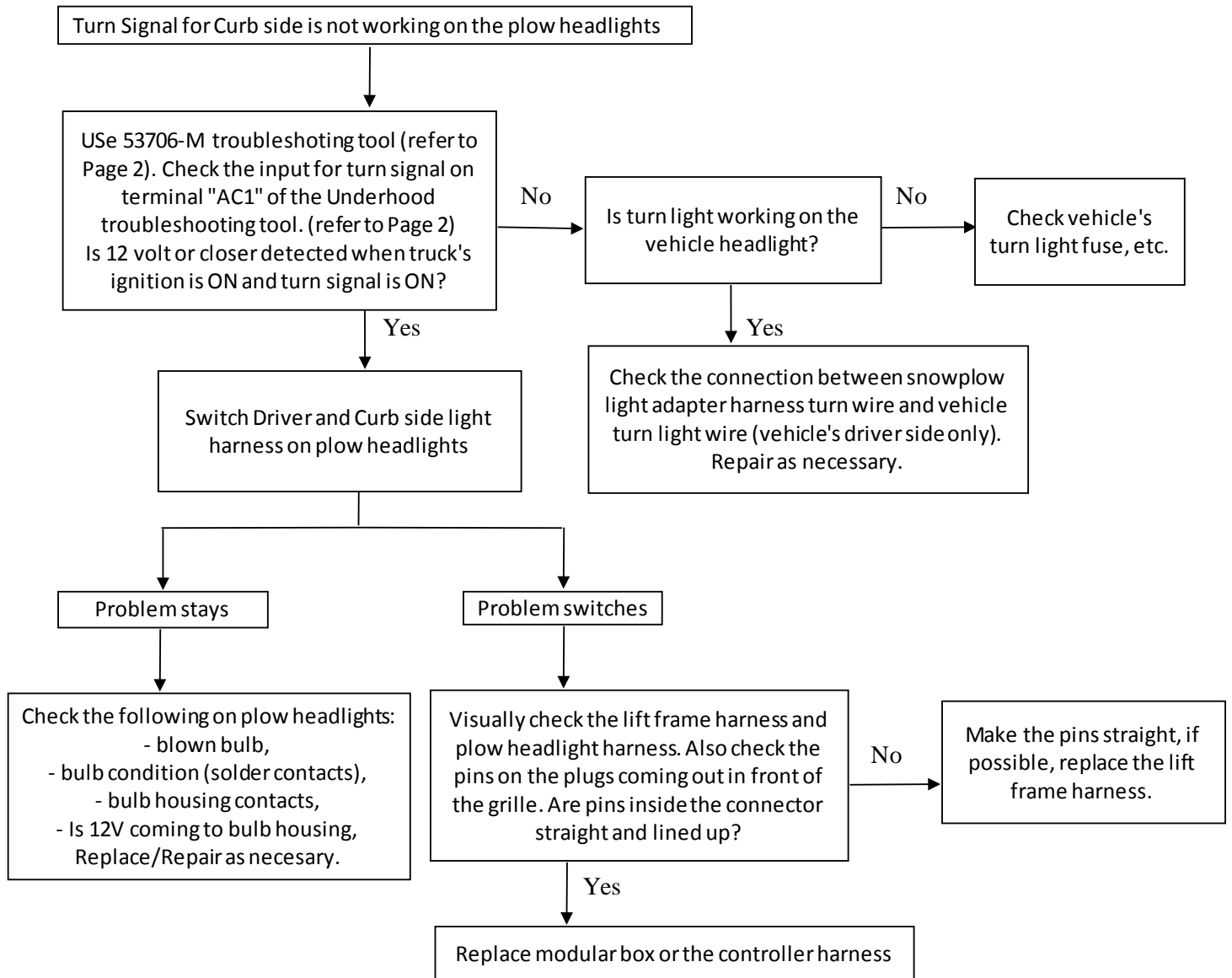

Restart truck's ignition after every step of troubleshooting.

Click on the link <https://www.youtube.com/watch?v=tZLjjQy-CIM> & https://www.youtube.com/watch?v=kBJUdXLc_z0 to watch the video of this specific troubleshooting step.

Link for 800084 headlights: <https://www.youtube.com/watch?v=LJlgbdwop8Q>

Link for 800085 headlights: <https://www.youtube.com/watch?v=fn09WLSG-vI>

Link for 800086 headlights: <https://www.youtube.com/watch?v=sA7AxDIYgwc>

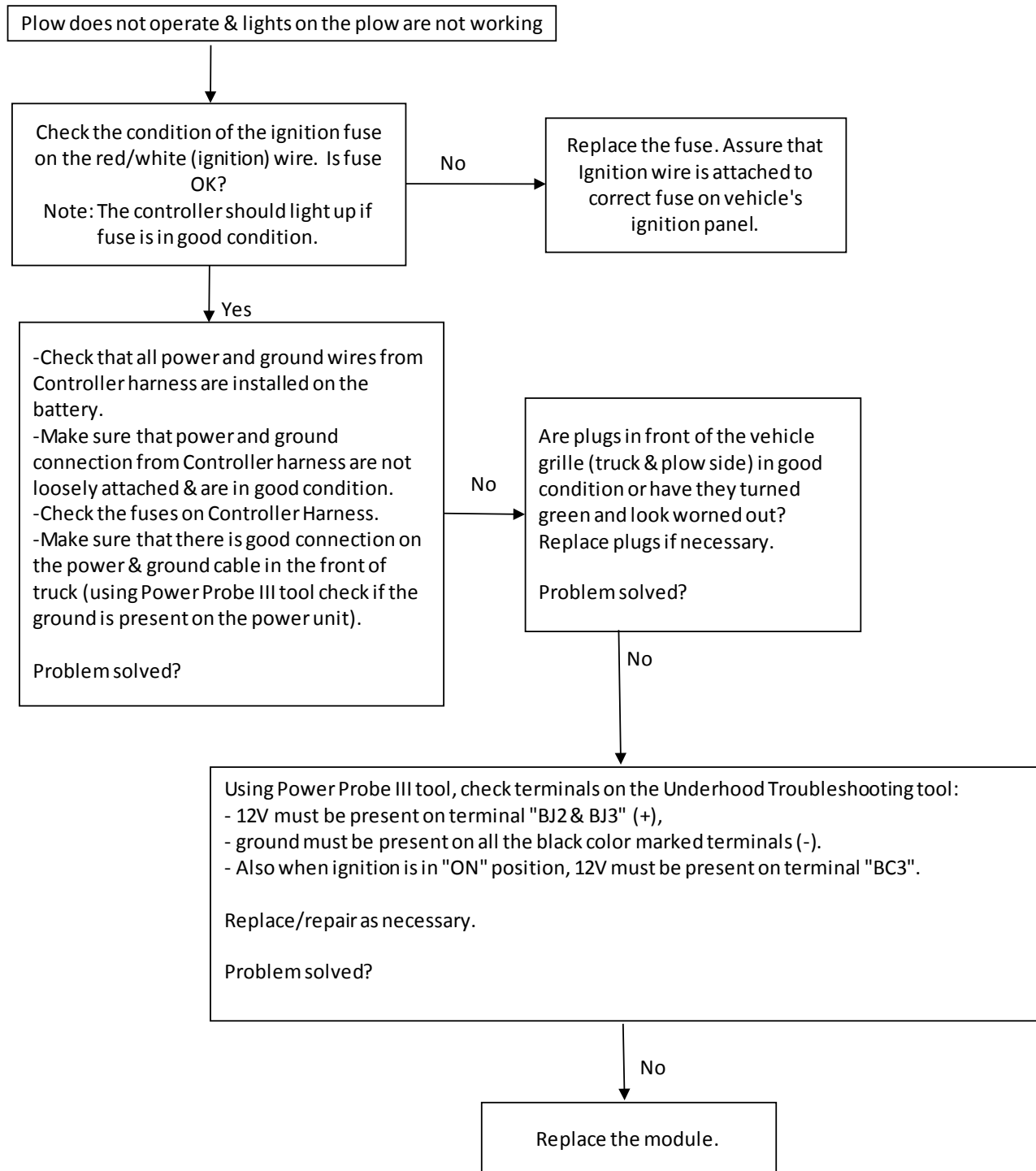

Restart truck's ignition after every step of troubleshooting.

Click on the link <https://www.youtube.com/watch?v=tZLjjQy-CIM> to watch the video of this specific troubleshooting step.

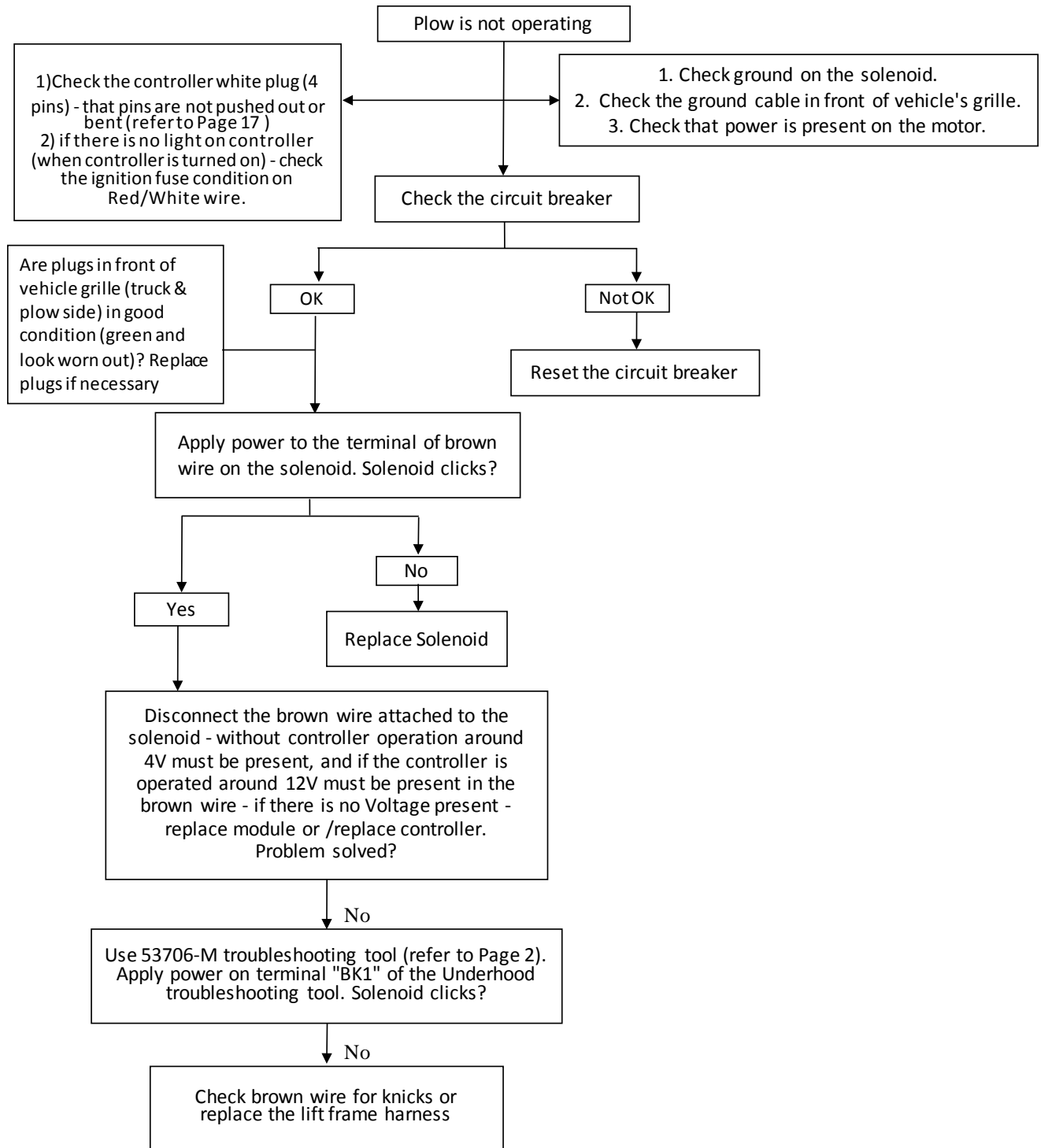

Restart truck's ignition after every step of troubleshooting.

Click on the link <https://www.youtube.com/watch?v=tZLjjQy-CIM> to watch the video of this specific troubleshooting step.

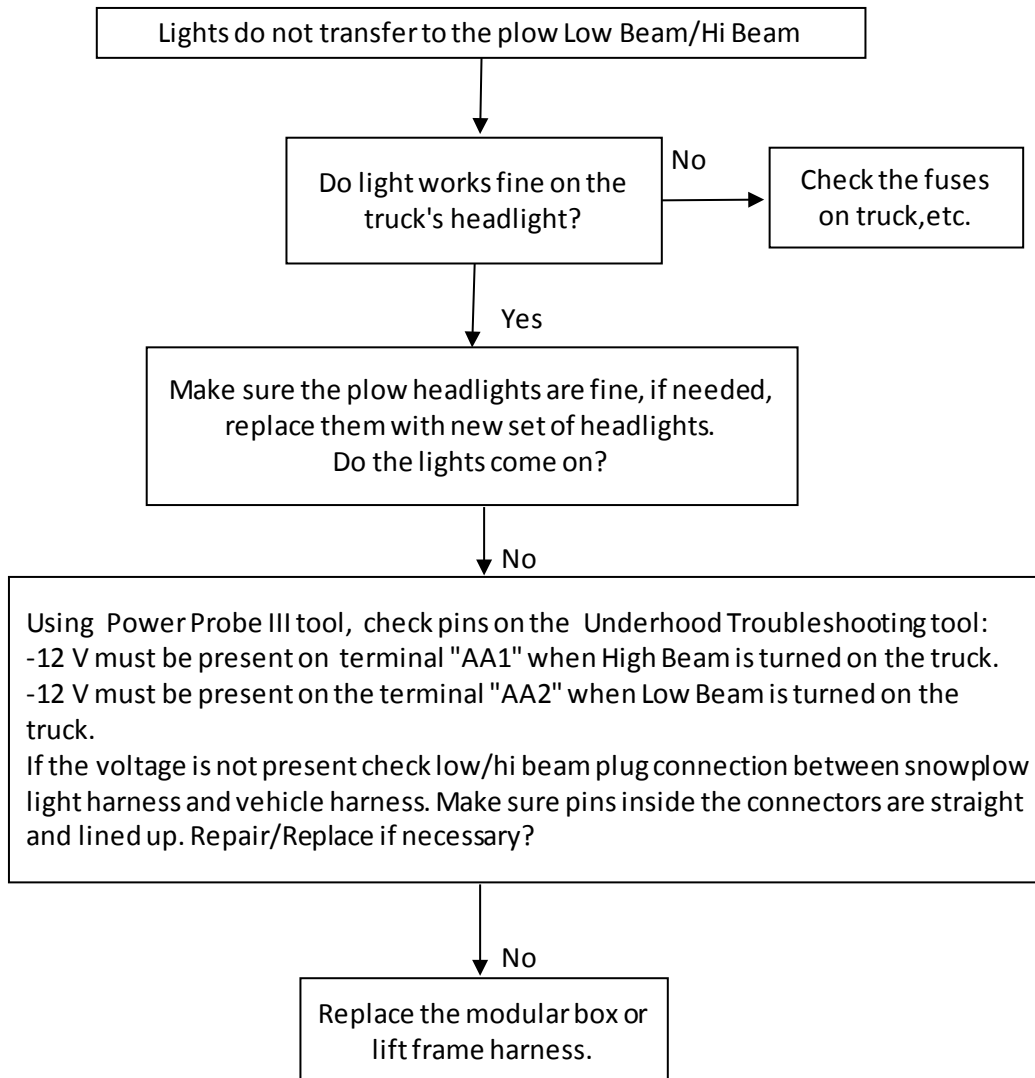

Restart truck's ignition after every step of troubleshooting.

Click on the link <https://www.youtube.com/watch?v=tZLjjQy-CIM> to watch the video of this specific troubleshooting step.

Link for 800084 headlights: <https://www.youtube.com/watch?v=LJlgbdwop8Q>

Link for 800085 headlights: <https://www.youtube.com/watch?v=fn09WLSG-vI>

Link for 800086 headlights: <https://www.youtube.com/watch?v=sA7AxDIYgwc>

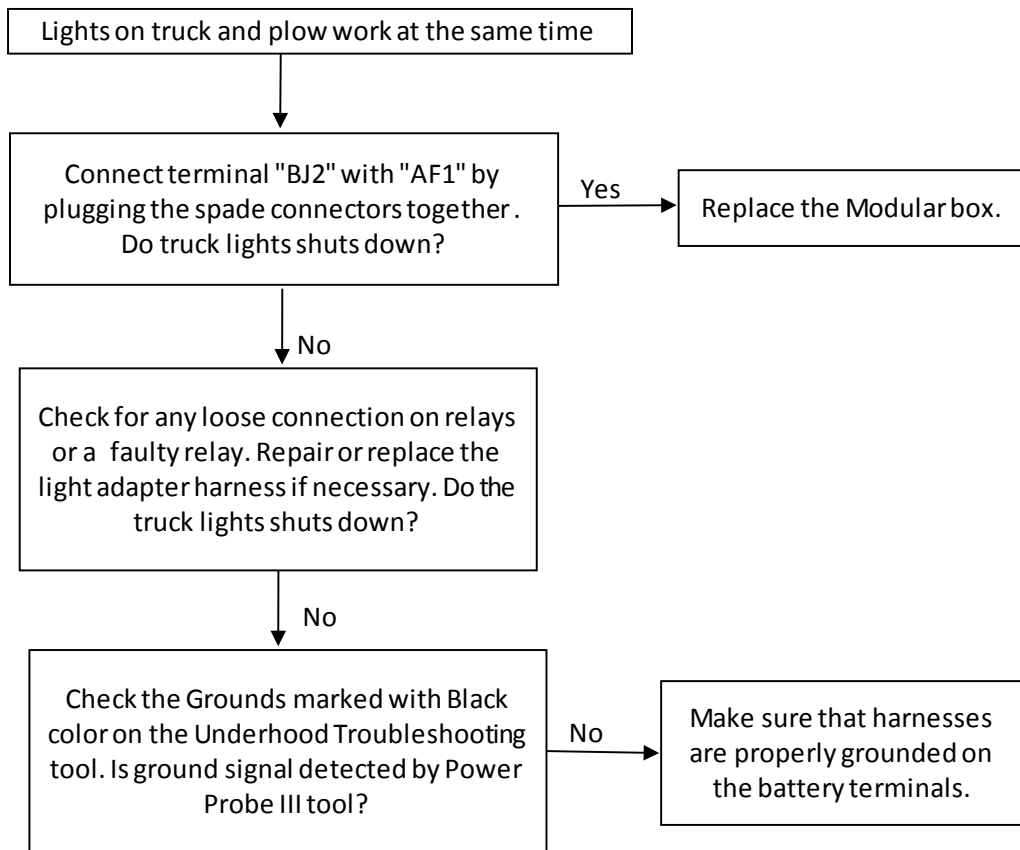

Restart truck's ignition after every step of troubleshooting.

Click on the link <https://www.youtube.com/watch?v=tZLjjQy-CIM> to watch the video of this specific troubleshooting step.

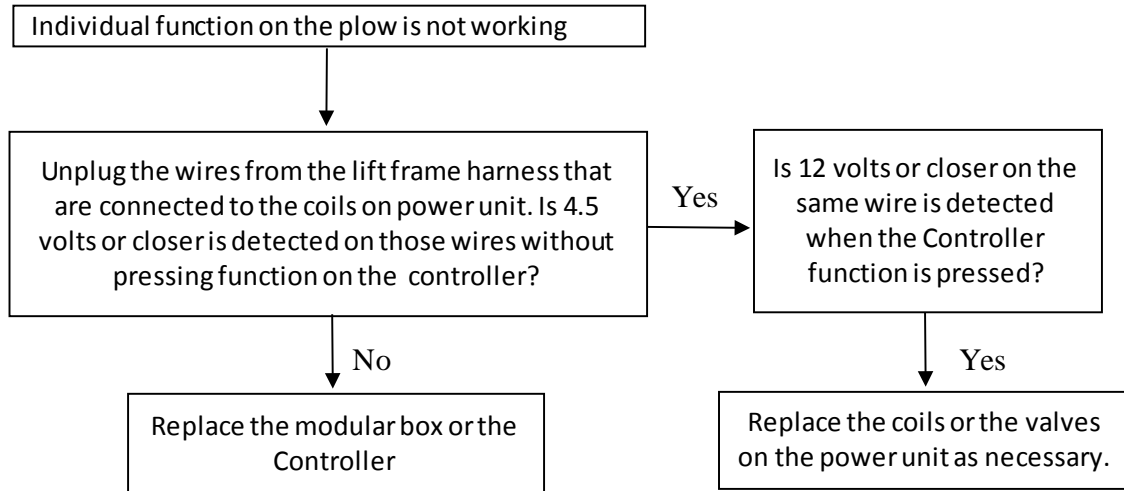

Restart truck's ignition after every step of troubleshooting.

Click on the link <https://www.youtube.com/watch?v=K1ERrFWnUw0> to watch the video of this specific troubleshooting step.

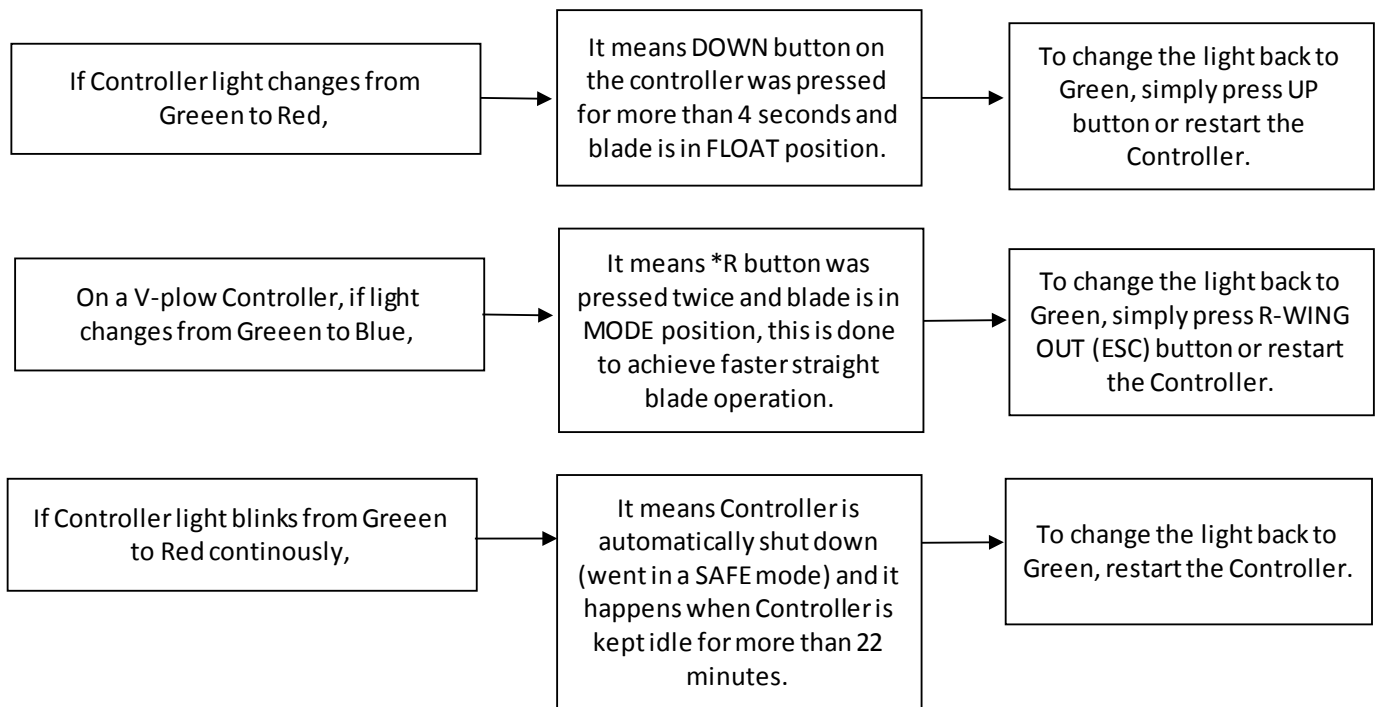

Restart truck's ignition after every step of troubleshooting.

Click on the link <https://www.youtube.com/watch?v=gKqEarX4FrQ> to watch the video of this specific troubleshooting step.

Connectors alignment for the MPX system

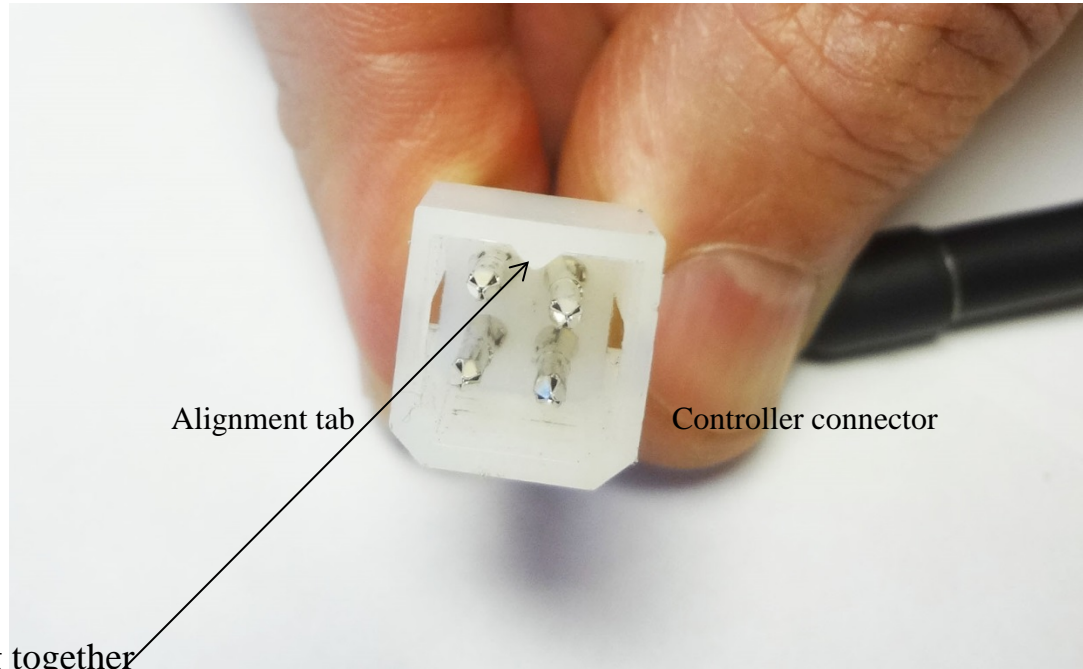

Must align before plugging together

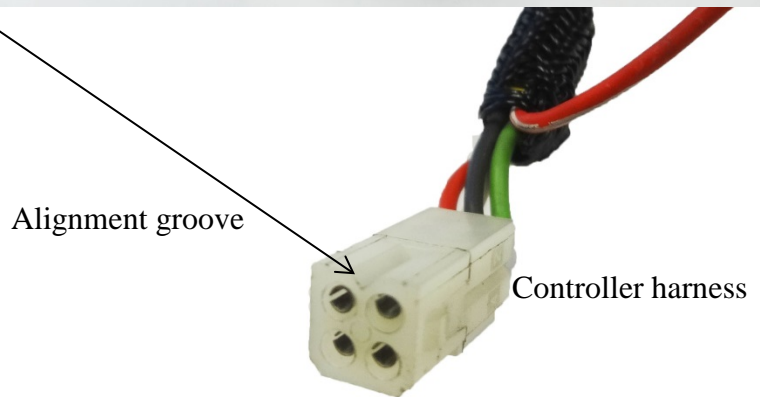

Tool for updating MPX module box (53707-N)



Check the link below to see step by step procedure on how to update the module box on your truck:

<https://www.youtube.com/watch?v=nGSTAm8hZ9Y>