

# **MPX troubleshooting flowchart**

## **Dodge 2500/3500/4500/5500**

### **2015 and above**

#### **(Using Snowplow 6 wires)**

Underhood Installation

(module installed under the vehicle's hood)

Important Note:

- Use **Power Probe III** tool to troubleshoot the MPX system.
- <https://www.youtube.com/watch?v=FuzfCOIA1Vw> – Link for Power Probe III tool instructions
- Update the modular box by updating tool (53707-M) if it was installed before 2017.
- See last page for more information on updating the modular box.
- See second page for more information on the Underhood Troubleshooting tool.

53706-M (Underhood Troubleshooting tool kit)

**To be plugged together all the time for troubleshooting underhood installation on Dodge 6 wires (2015 and above)**

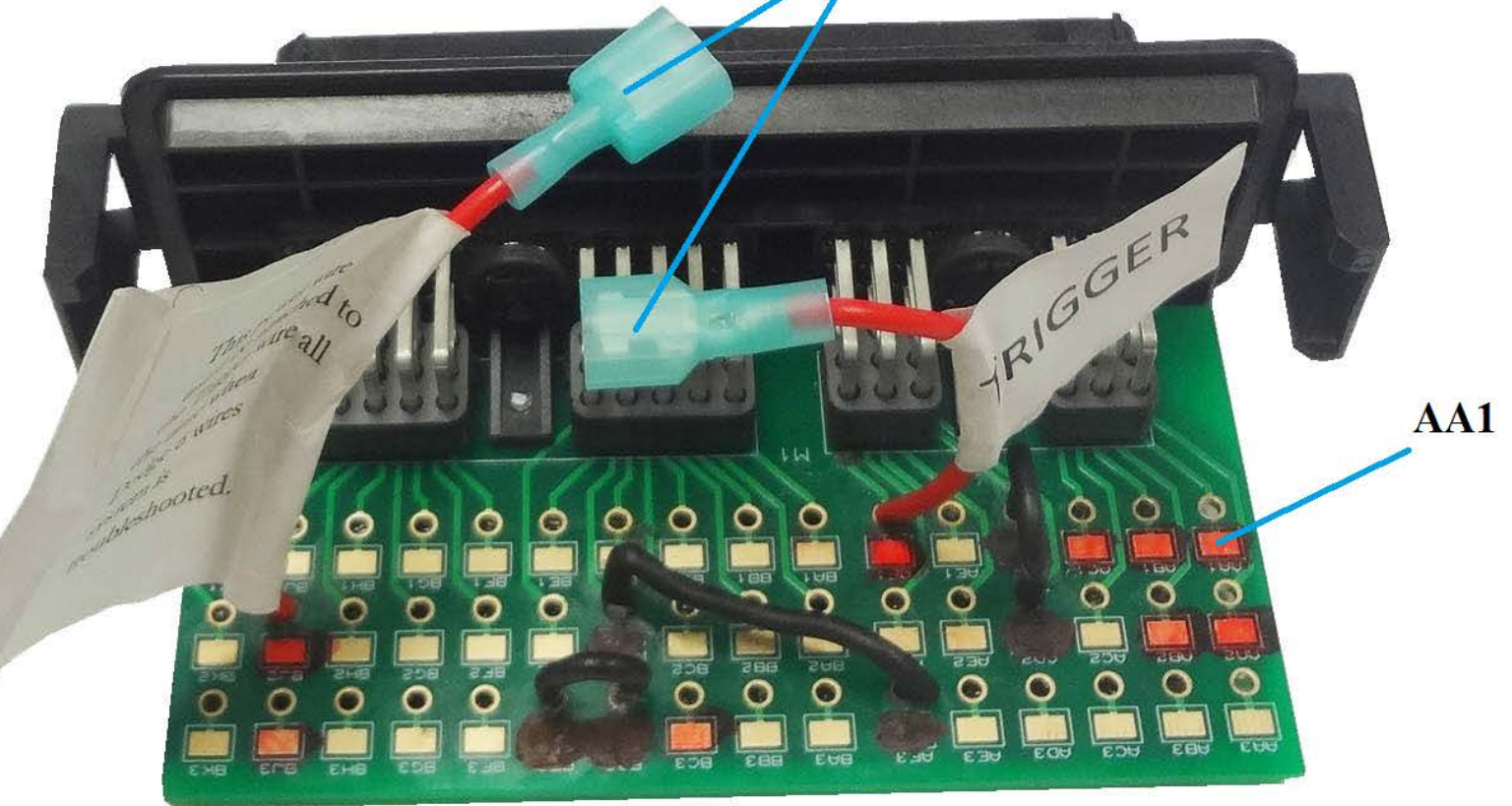

Terminal on the tool	Functions of the terminal
AA1	High Beam
AA2	Low Beam
AB1	Driver Side Turn
AB2	Driver Side Park
AC1	Curb Side Turn
AF1	Trigger
BC3	Ignition
BJ2	Power wire (Battery connection)
BJ3	Power wire (Battery connection)
BK1	Solenoid (Brown wire)

Note: Terminal Marked with Black color are Grounds.

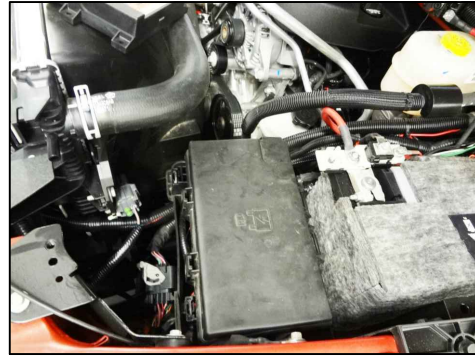

Unclip the fuse box

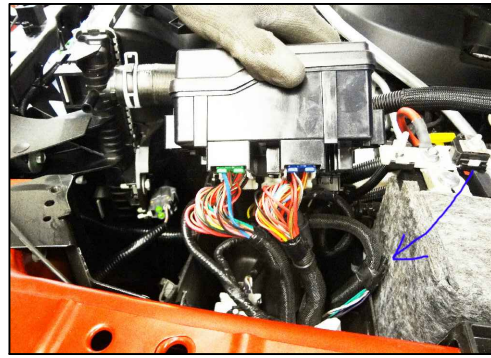

Lift the box and find 6 wires, attach them to the harness as shown

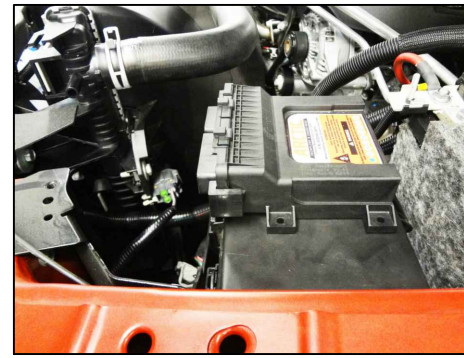

Plug the harness in the control module; install module on the fuse box

- Install VELCRO stick back tape on the bottom of the module and on top of the fuse box

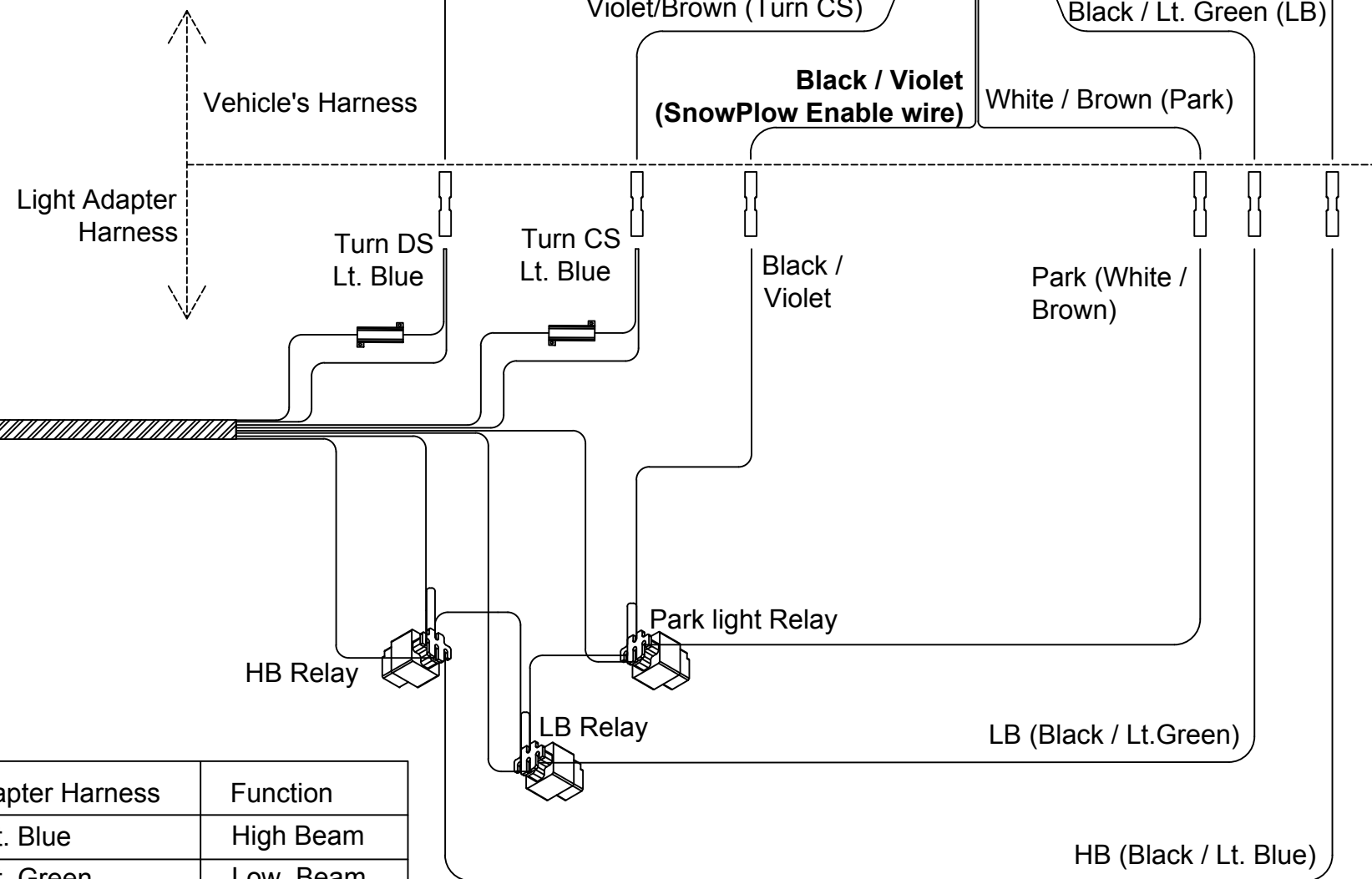
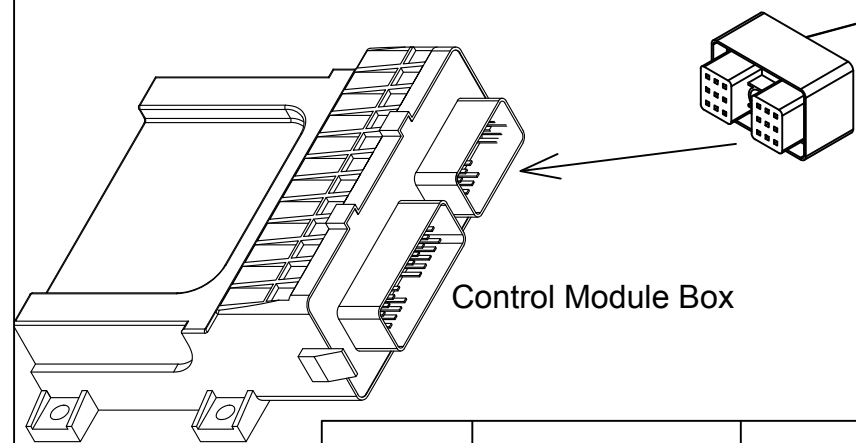

	Vehicle Harness		Light Adapter Harness	Function
Connect	Black/Lt. Blue	To	Black / Lt. Blue	High Beam
Connect	Black/Lt. Green	To	Black / Lt. Green	Low Beam
Connect	White/Brown	To	White / Brown	Park
Connect	White/Violet	To	Lt. Blue	DS Turn
Connect	Violet/Brown	To	Lt. Blue	CS Turn
Connect	Black/Violet	To	Black / Violet	Snowplow Enable wire

LEGEND

DS- Driver Side  
 CS - Curb Side  
 HB - High Beam  
 LB - Low Beam

Click on the link below to refer to the specific troubleshooting step:

- Marker/Position lights on one side of plow headlights is not working.
- Marker/Position lights on both the sides of plow headlights are not working
- High beam / Low beam on one side of the plow headlight is not working.
- High beam on both the sides of plow headlights are not working.
- Low beam on both the sides of plow headlights are not working.
- Turn Signal on Driver side of the plow headlight is not working.
- Turn Signal on Curb side of the plow headlight is not working.
- Plow does not operate and lights on the plow are not working.
- Plow does not operate.
- Lights do not transfer to the plow.
- Individual functions on the plow are not working.
- Controller lights keep on changing.

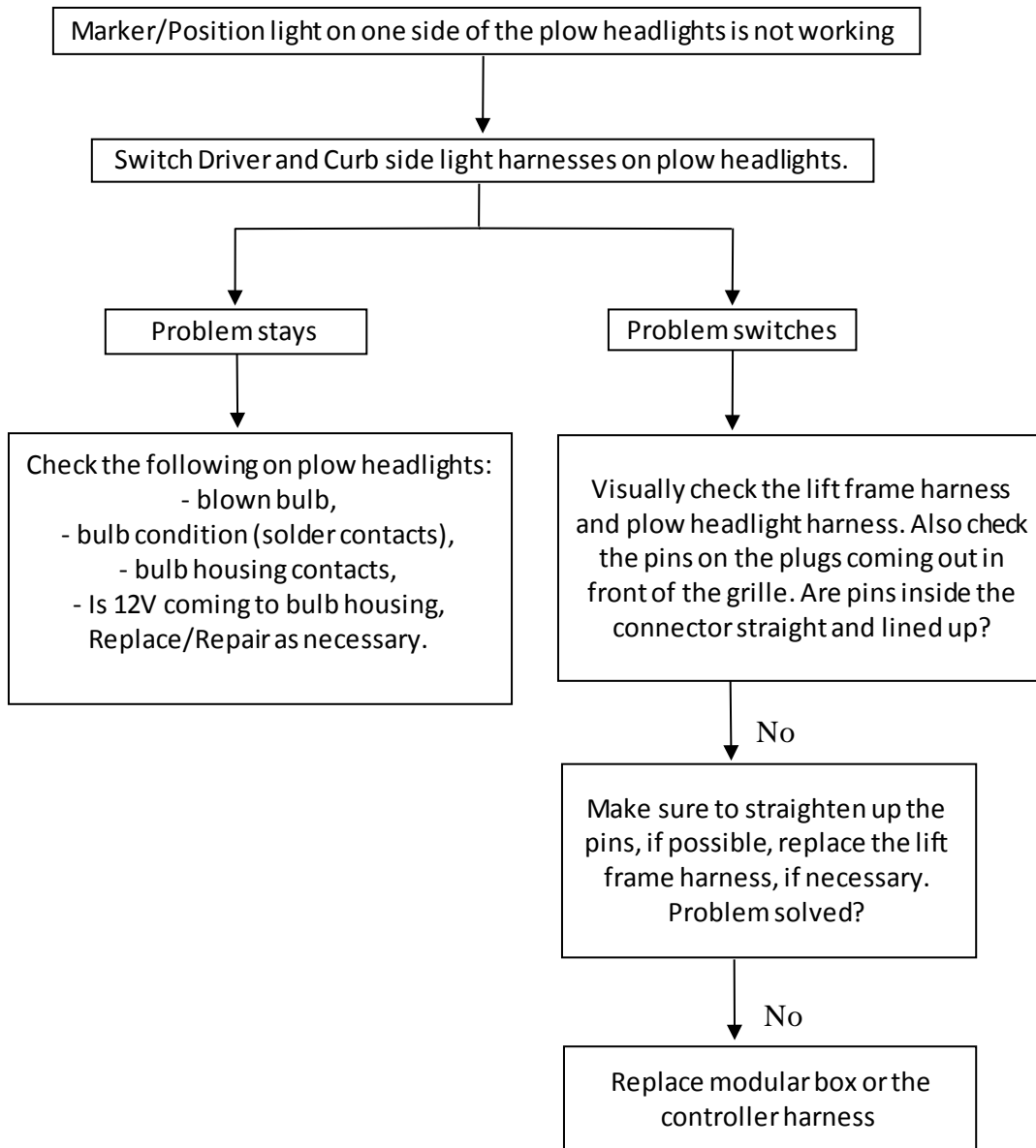

**Restart truck's ignition after every step of troubleshooting.**

Click on <https://www.youtube.com/watch?v=ErBX0E5GpeE&feature=youtu.be> to watch the video of this specific troubleshooting step.

Link for 800084 headlights: <https://www.youtube.com/watch?v=LJlgbdwop8Q>

Link for 800085 headlights: <https://www.youtube.com/watch?v=fn09WLSG-vI>

Link for 800086 headlights: <https://www.youtube.com/watch?v=sA7AxDIYgwc>

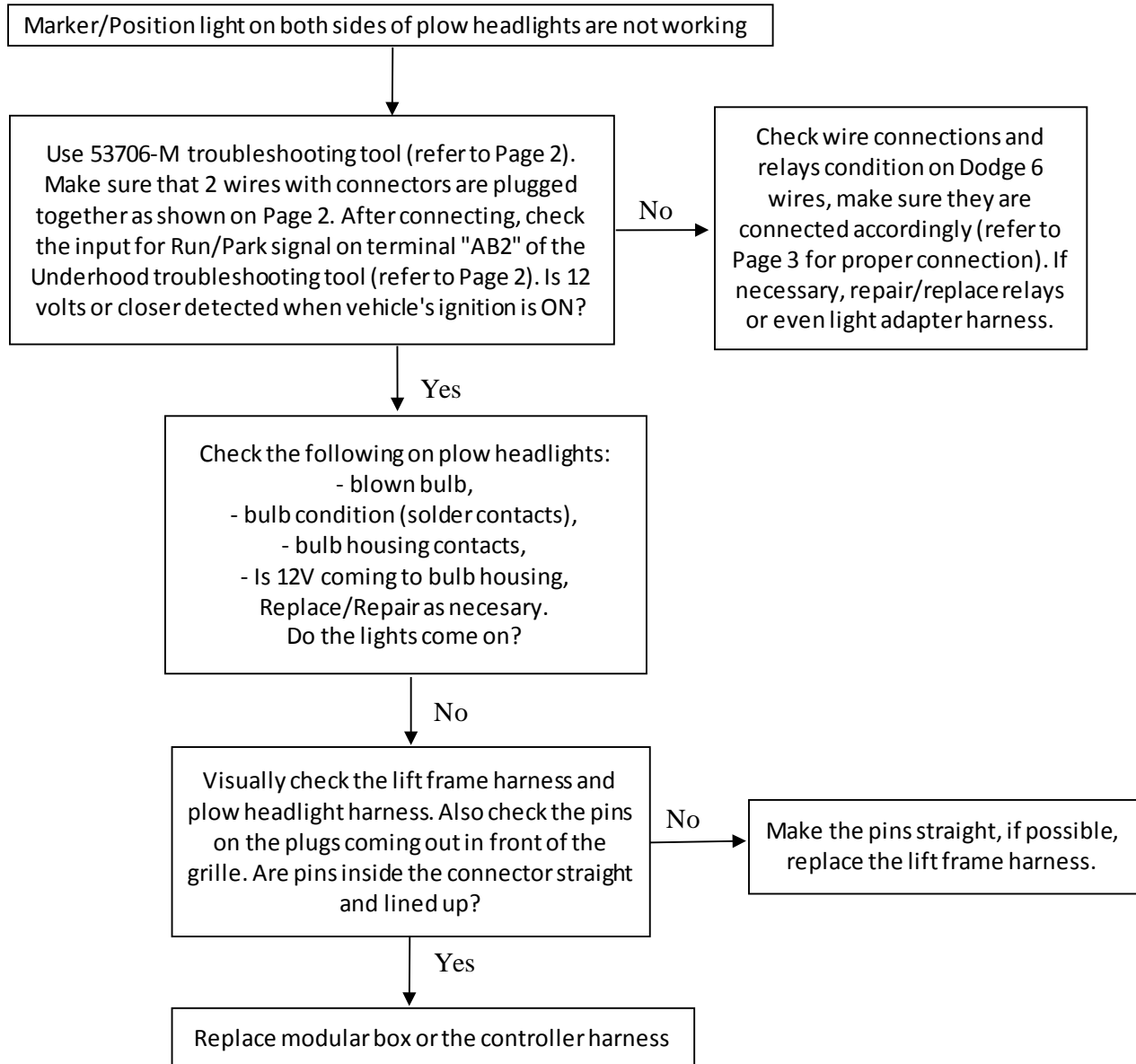

**Restart truck's ignition after every step of troubleshooting.**

Click on the link <https://www.youtube.com/watch?v=0oSPpkrZCOE> & [https://www.youtube.com/watch?v=-CD8N07SB\\_s](https://www.youtube.com/watch?v=-CD8N07SB_s) to watch the video of this specific troubleshooting step.

Link for 800084 headlights: <https://www.youtube.com/watch?v=LJlgbdwop8Q>

Link for 800085 headlights: <https://www.youtube.com/watch?v=fn09WLSG-vI>

Link for 800086 headlights: <https://www.youtube.com/watch?v=sA7AxDIYgwc>

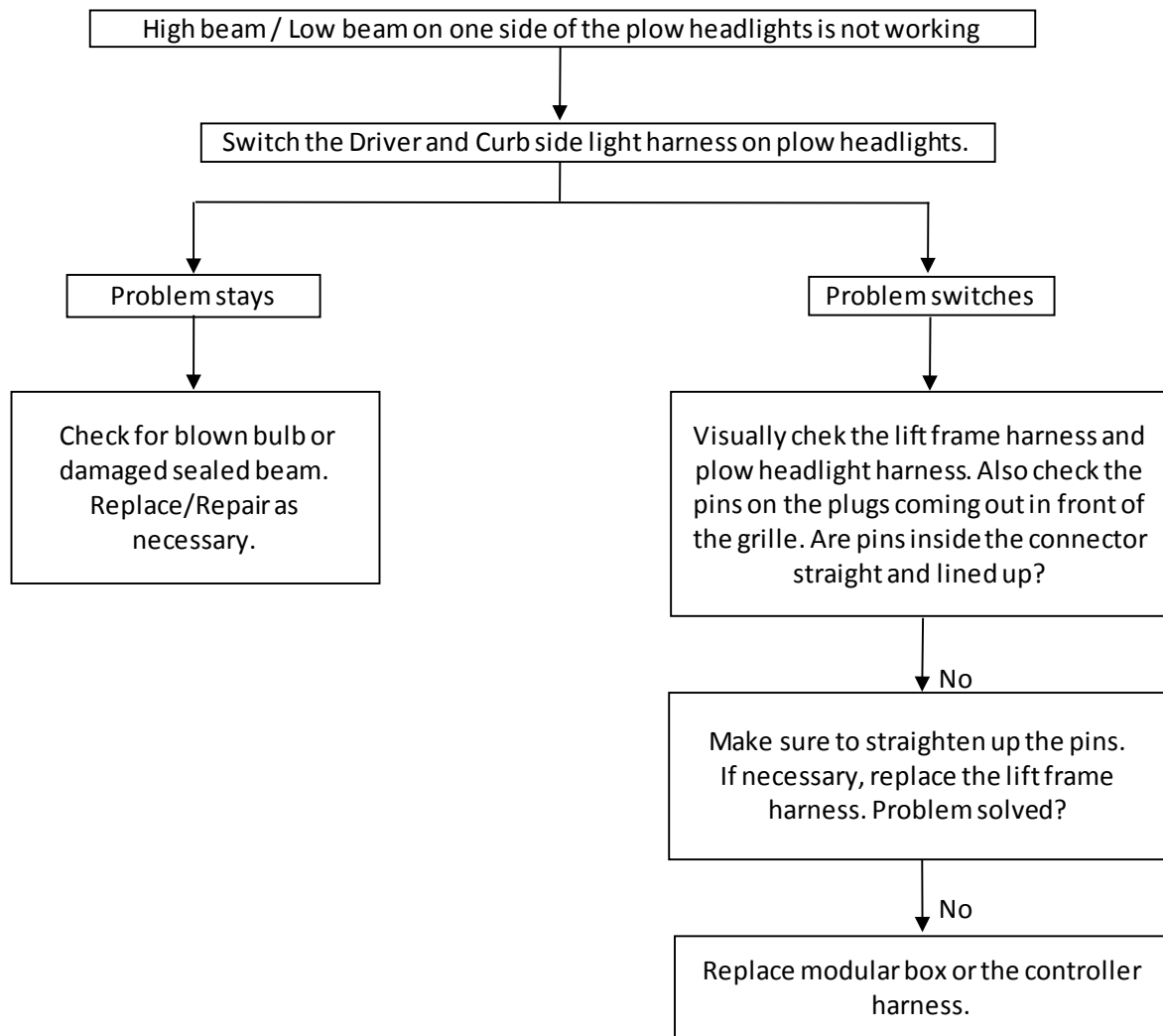

Restart truck's ignition after every step of troubleshooting.

Click on link <https://www.youtube.com/watch?v=7wruoLUVfdI> to watch the video of this specific troubleshooting step.

Link for 800084 headlights: <https://www.youtube.com/watch?v=LJlgbdwop8Q>

Link for 800085 headlights: <https://www.youtube.com/watch?v=fn09WLSG-vI>

Link for 800086 headlights: <https://www.youtube.com/watch?v=sA7AxDIYgwc>

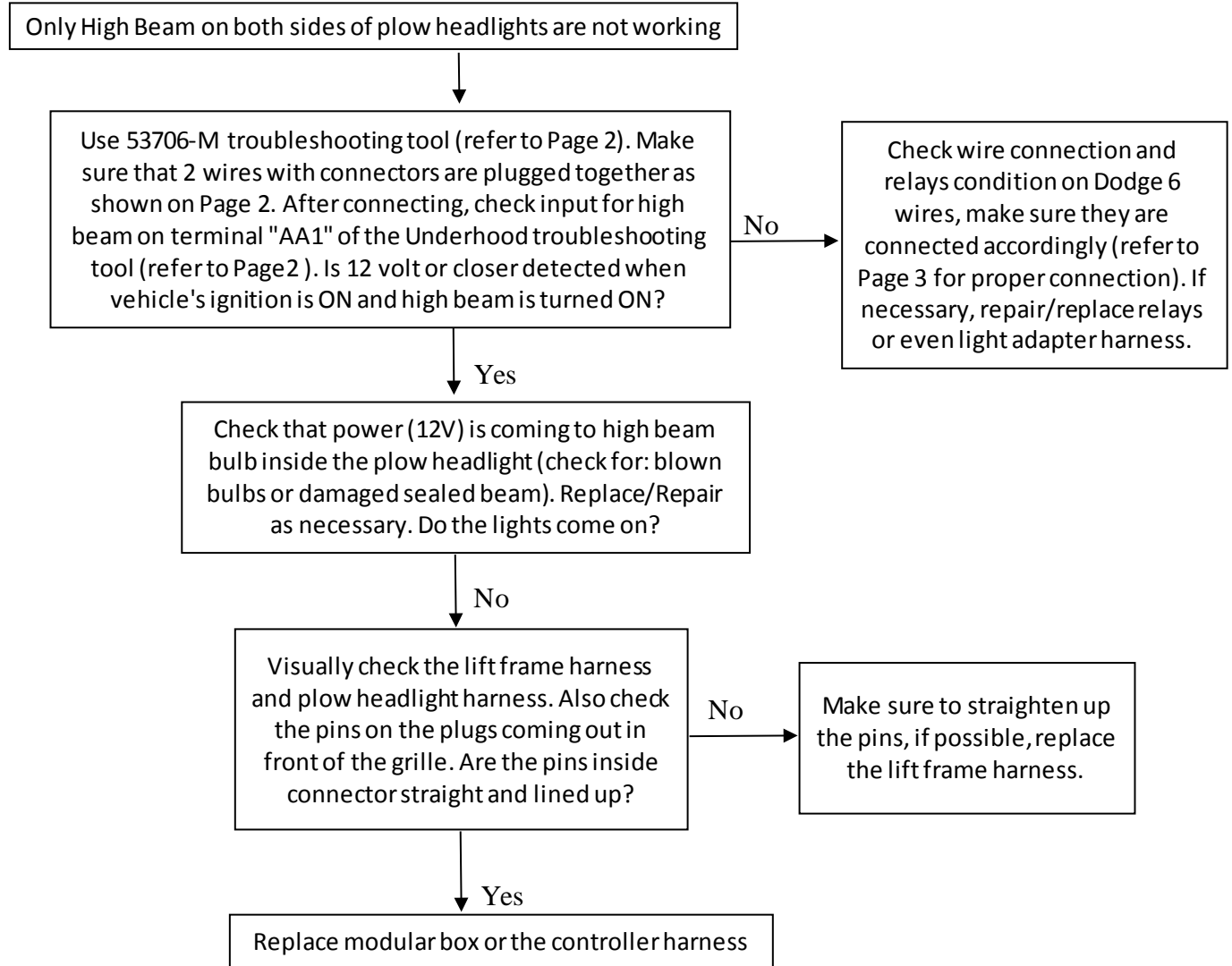

Restart truck's ignition after every step of troubleshooting.

Click on the link <https://www.youtube.com/watch?v=0oSPpkrZCOE> & <https://www.youtube.com/watch?v=NDnCfwl3ftU> to watch the video of this specific troubleshooting step.

Link for 800084 headlights: <https://www.youtube.com/watch?v=LJlgbdwop8Q>

Link for 800085 headlights: <https://www.youtube.com/watch?v=fn09WLSG-vI>

Link for 800086 headlights: <https://www.youtube.com/watch?v=sA7AxDIYgwc>



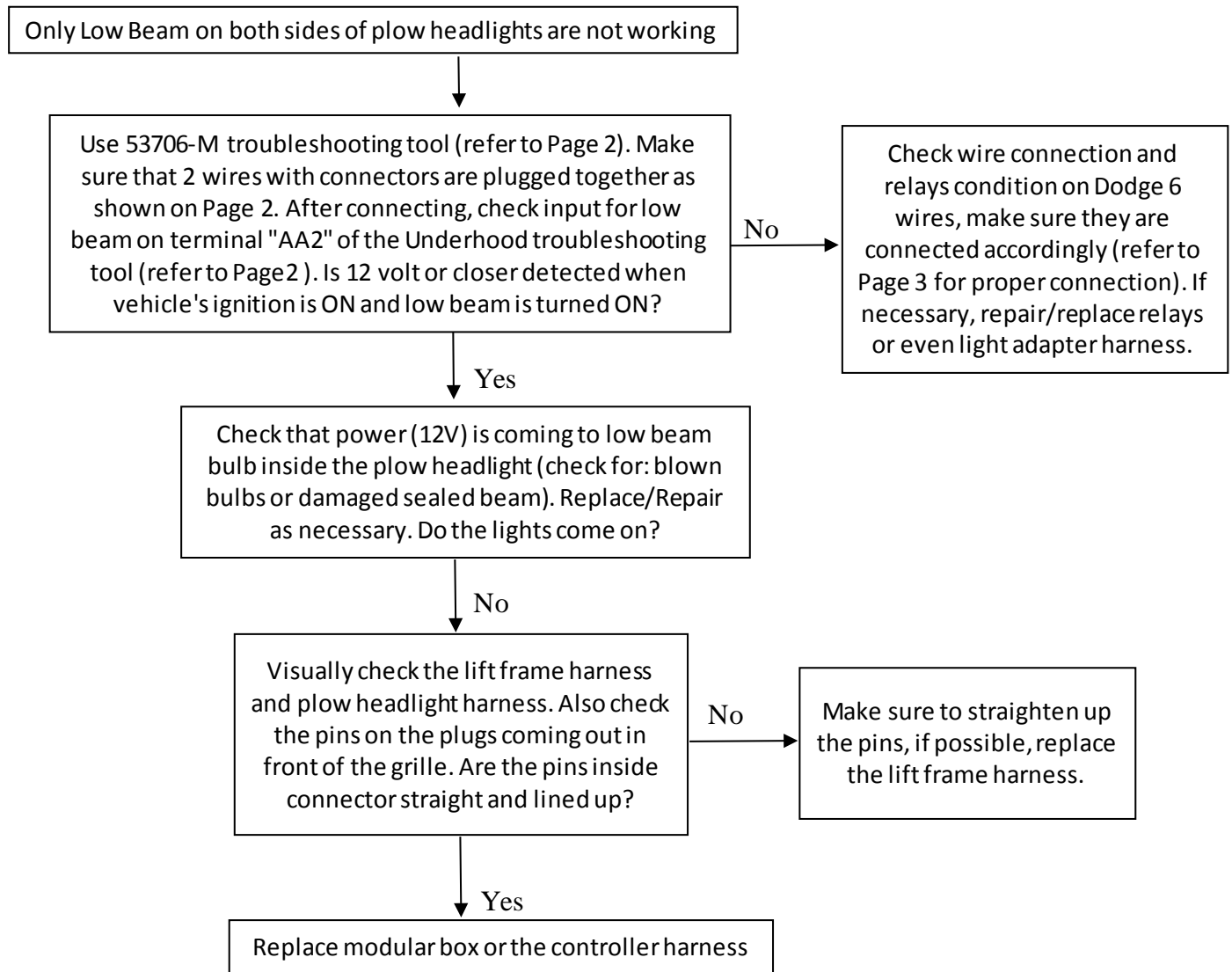

**Restart truck's ignition after every step of troubleshooting.**

Click on the link <https://www.youtube.com/watch?v=0oSPpkrZCOE> & [https://www.youtube.com/watch?v=Qyg0\\_3bFPGE](https://www.youtube.com/watch?v=Qyg0_3bFPGE) to watch the video of this specific troubleshooting step.

Link for 800084 headlights: <https://www.youtube.com/watch?v=LJlgbdwop8Q>

Link for 800085 headlights: <https://www.youtube.com/watch?v=fn09WLSG-vI>

Link for 800086 headlights: <https://www.youtube.com/watch?v=sA7AxDIYgwc>

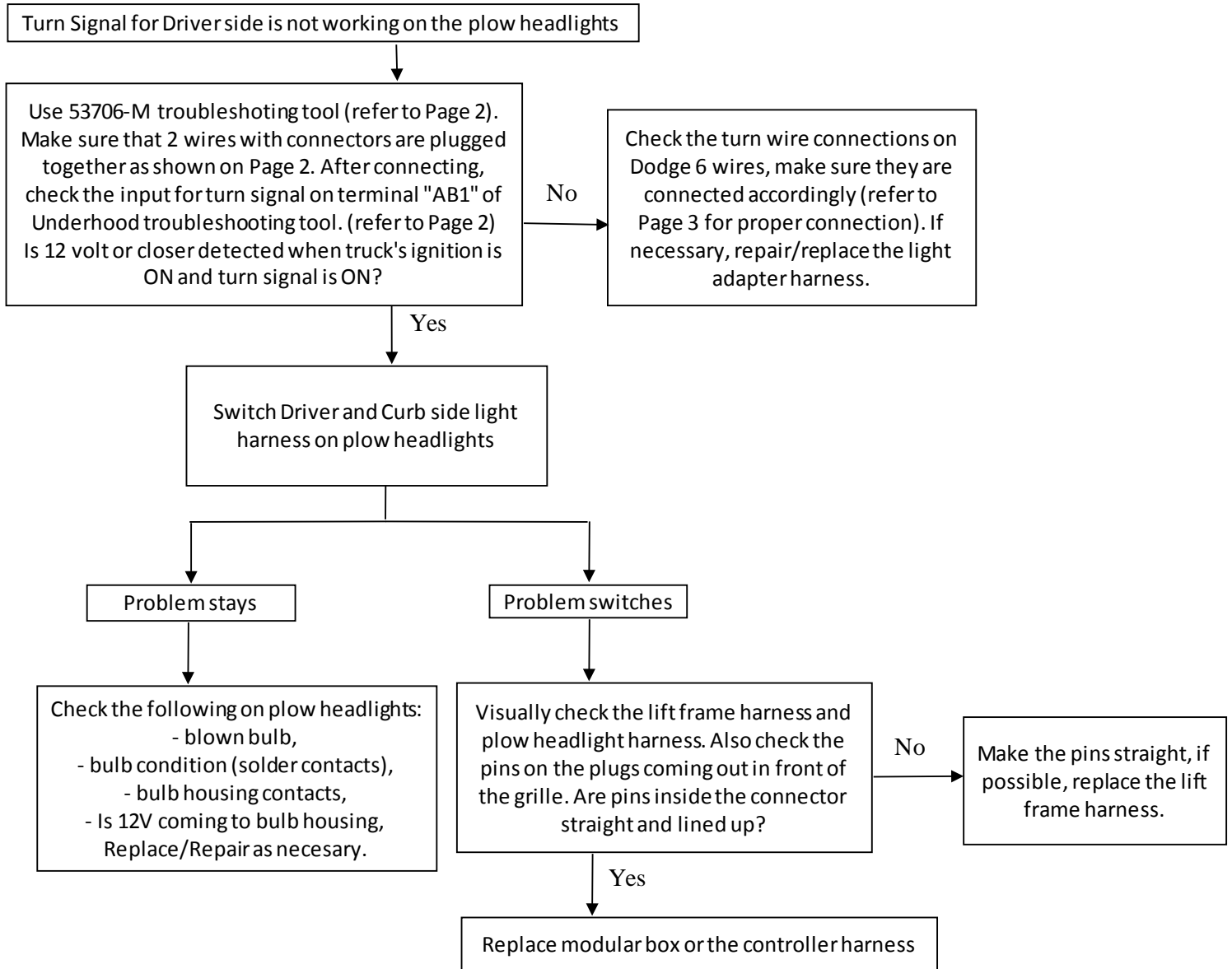

**Restart truck’s ignition after every step of troubleshooting.**

Click on the link <https://www.youtube.com/watch?v=0oSPpkrZCOE> & <https://www.youtube.com/watch?v=WckVZFUPIVQ> to watch the video of this specific troubleshooting step.

Link for 800084 headlights: <https://www.youtube.com/watch?v=LJlgbdwop8Q>

Link for 800085 headlights: <https://www.youtube.com/watch?v=fn09WLSG-vI>

Link for 800086 headlights: <https://www.youtube.com/watch?v=sA7AxDIYgwc>

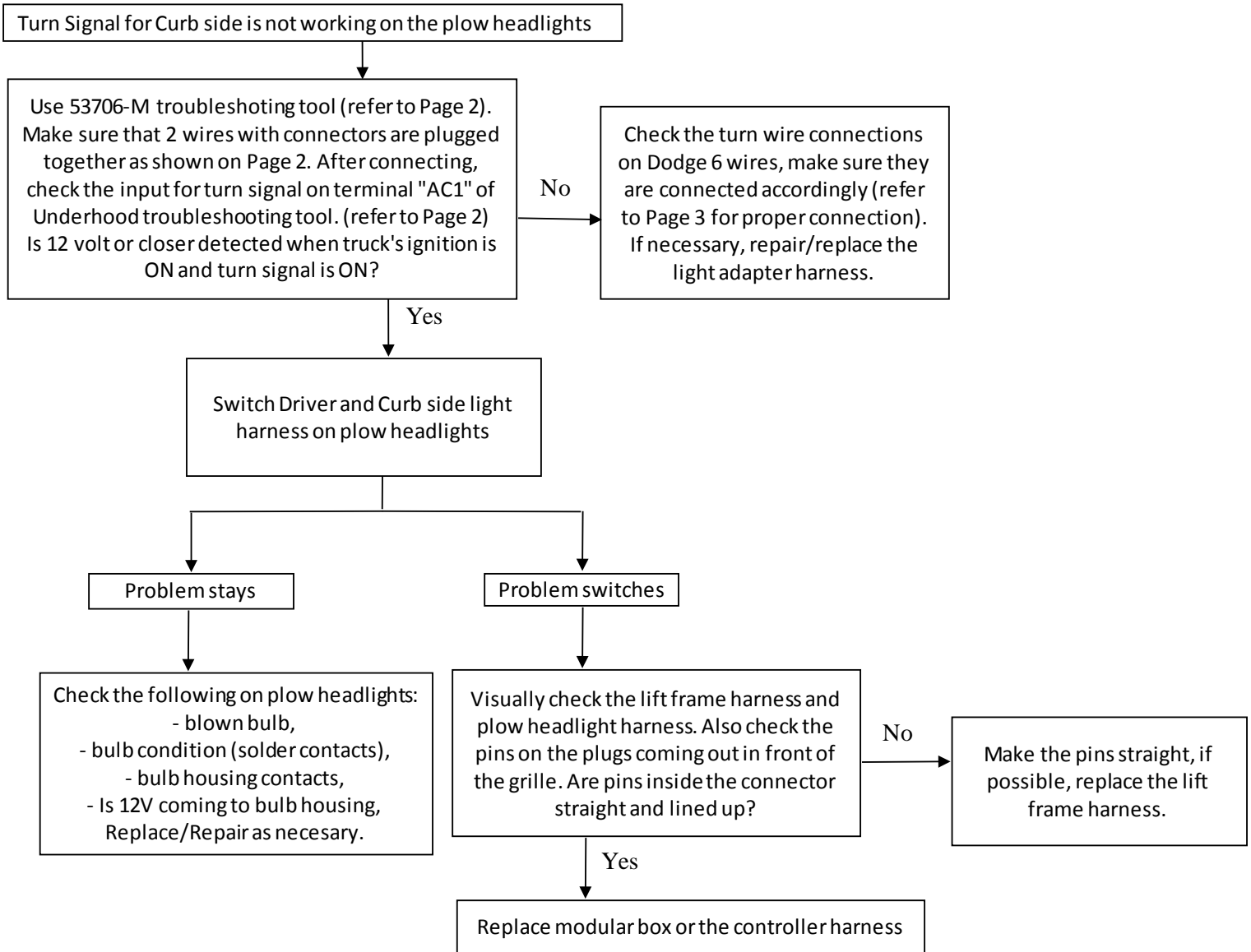

**Restart truck’s ignition after every step of troubleshooting.**

Click on the link <https://www.youtube.com/watch?v=0oSPpkrZCOE> & <https://www.youtube.com/watch?v=2yG1dkX8q9Y> to watch the video of this specific troubleshooting step.

Link for 800084 headlights: <https://www.youtube.com/watch?v=LJlgbdwop8Q>

Link for 800085 headlights: <https://www.youtube.com/watch?v=fn09WLSG-vI>

Link for 800086 headlights: <https://www.youtube.com/watch?v=sA7AxDIYgwc>

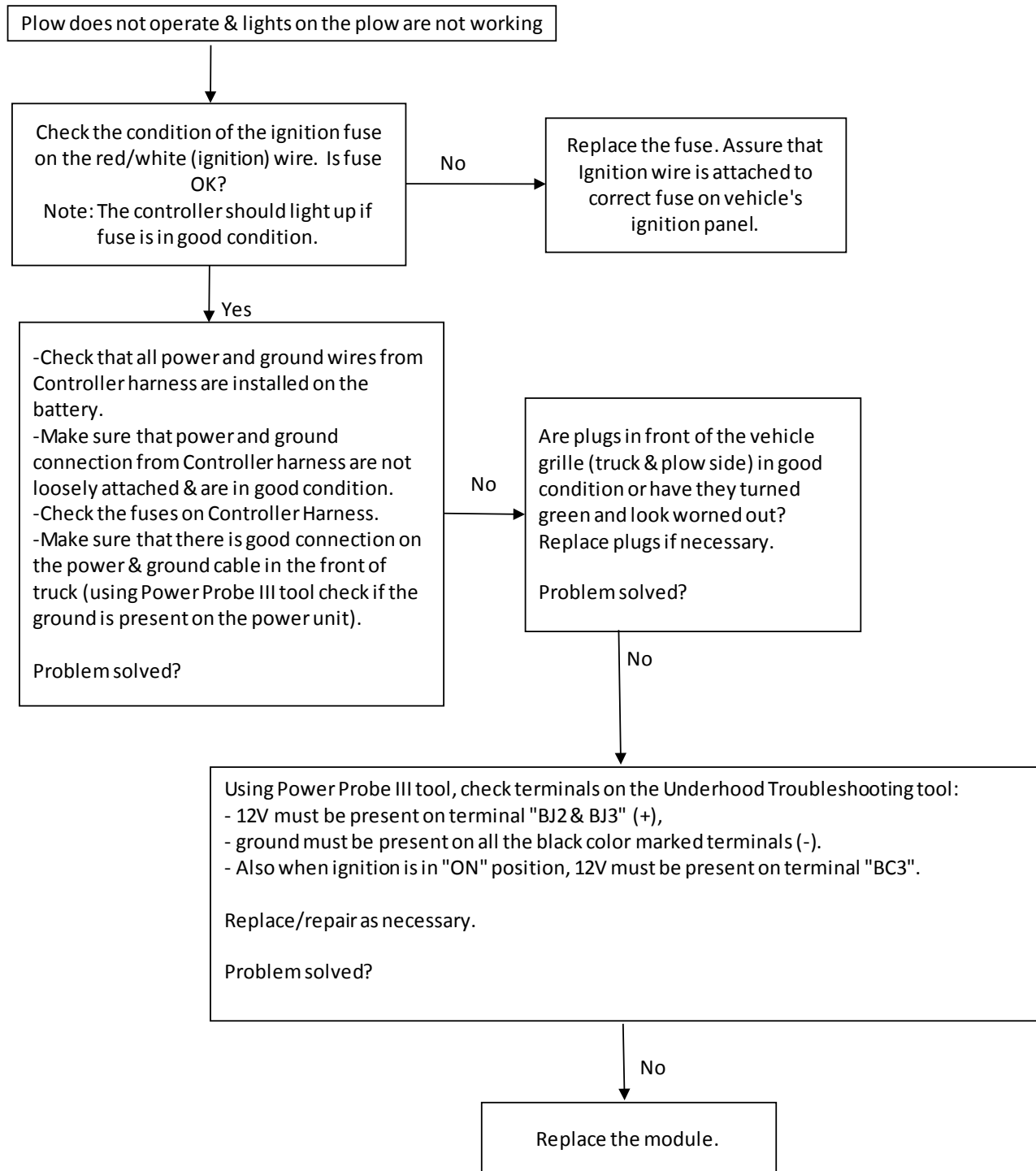

Restart truck's ignition after every step of troubleshooting.

Click on the link <https://www.youtube.com/watch?v=0oSPpkrZCOE> to watch the video of this specific troubleshooting step.

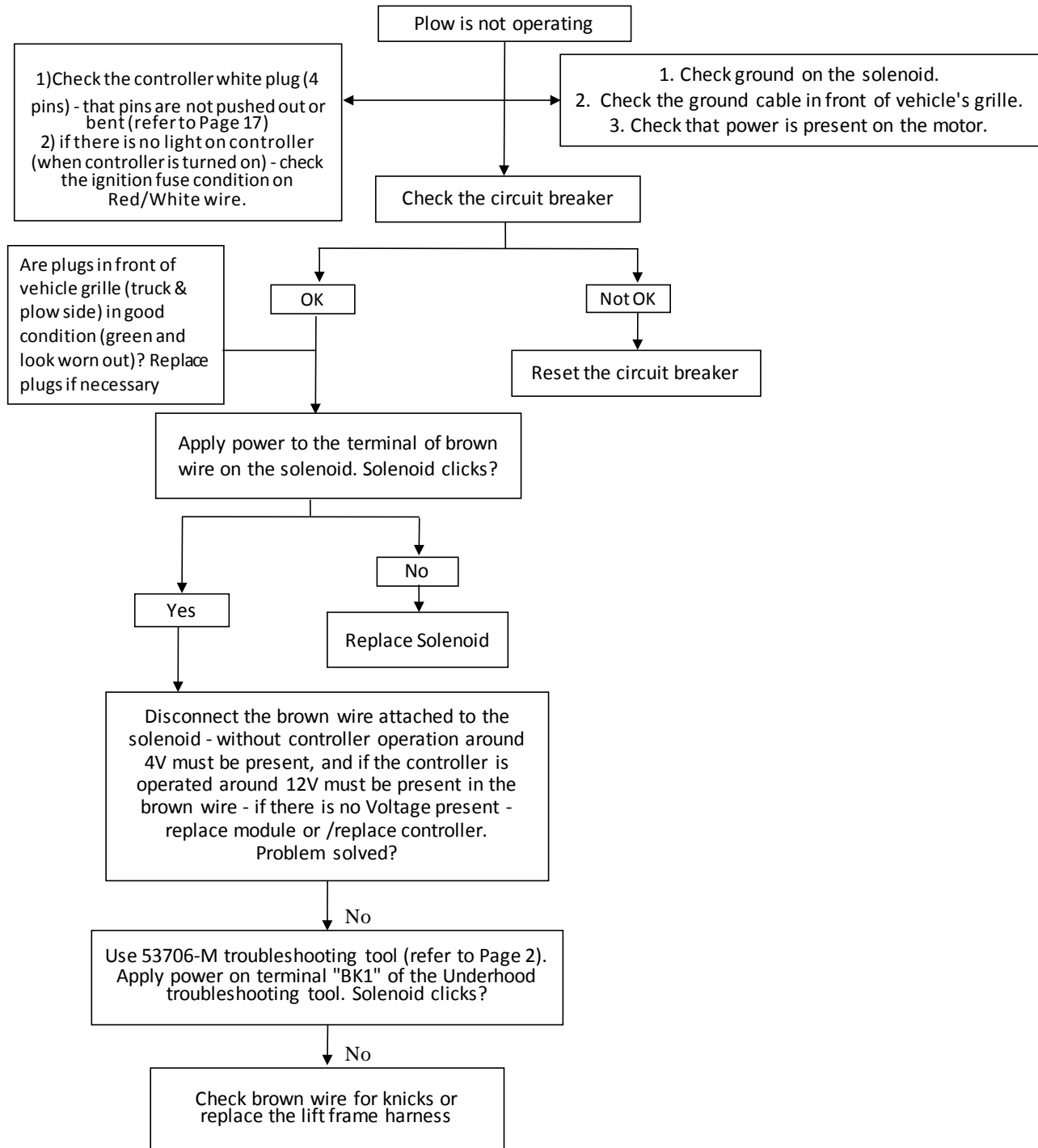

Restart truck's ignition after every step of troubleshooting.

Click on the link <https://www.youtube.com/watch?v=0oSPpkrZCOE> to watch the video of this specific troubleshooting step.

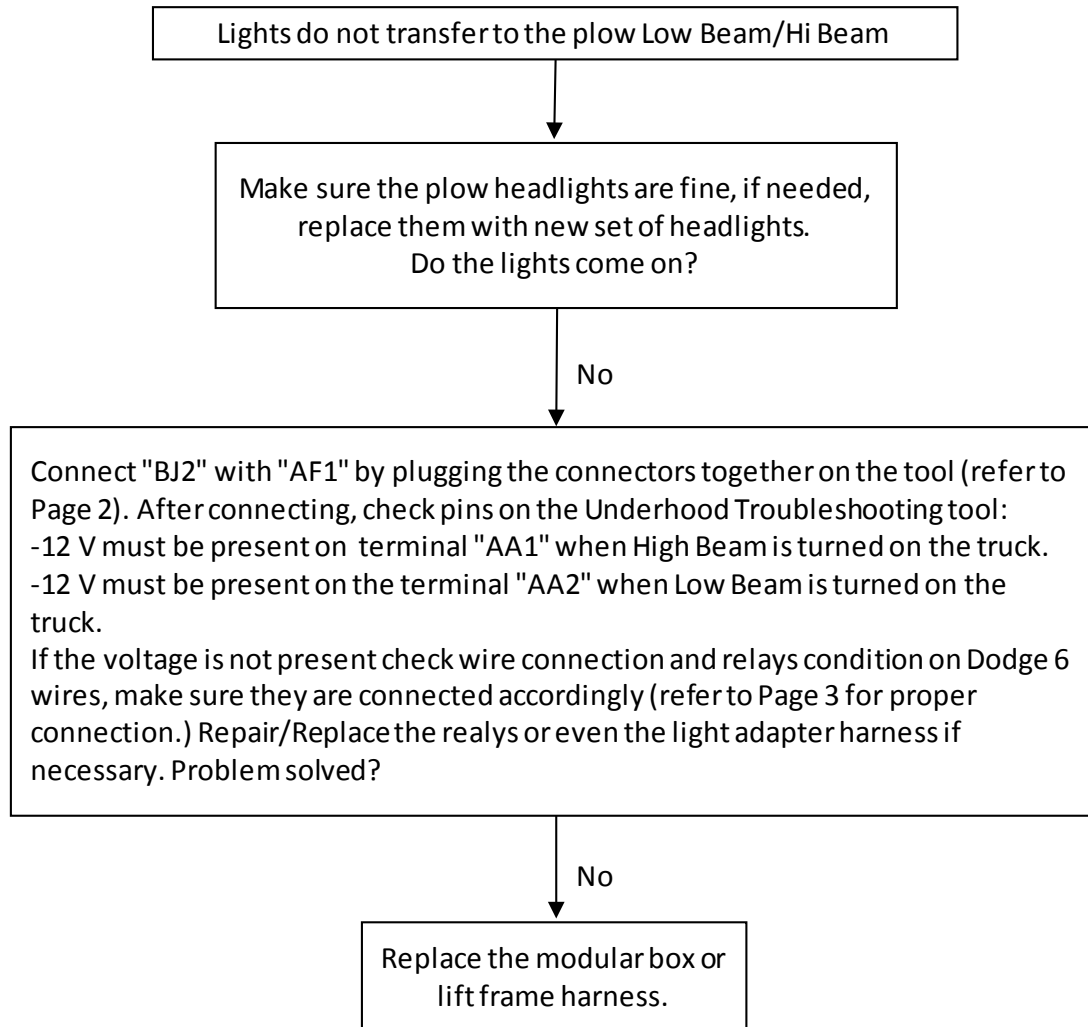

**Restart truck's ignition after every step of troubleshooting.**

Click on the link <https://www.youtube.com/watch?v=0oSPpkrZCOE> to watch the video of this specific troubleshooting step.

Link for 800084 headlights: <https://www.youtube.com/watch?v=LJlgbdwop8Q>

Link for 800085 headlights: <https://www.youtube.com/watch?v=fn09WLSG-vI>

Link for 800086 headlights: <https://www.youtube.com/watch?v=sA7AxDIYgwc>

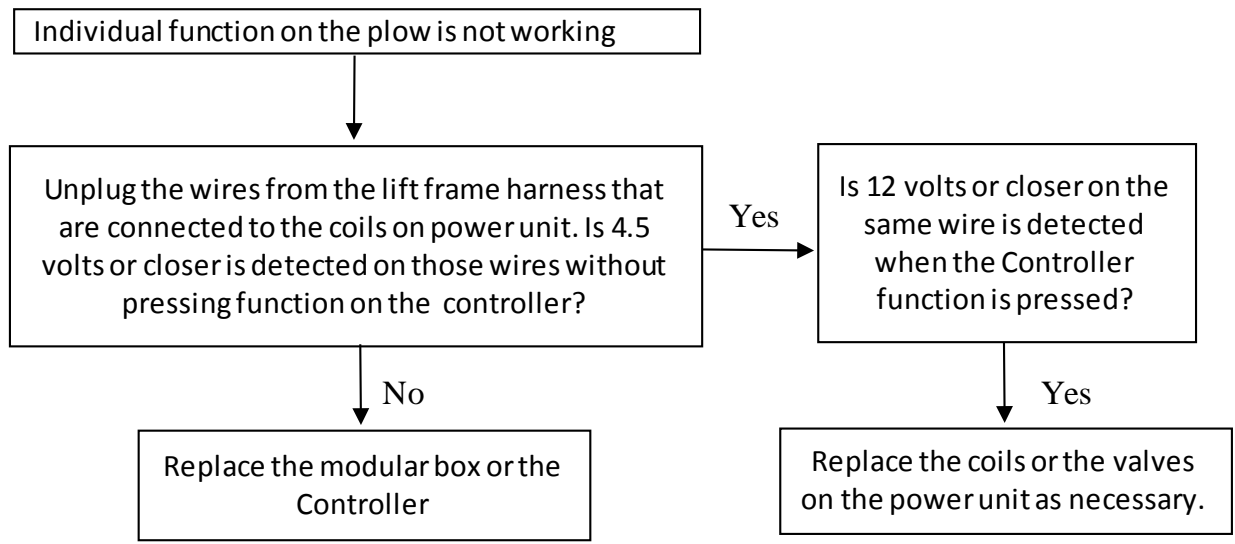

**Restart truck's ignition after every step of troubleshooting.**

Click on the link <https://www.youtube.com/watch?v=K1ERrFWnUw0> to watch the video of this specific troubleshooting step.

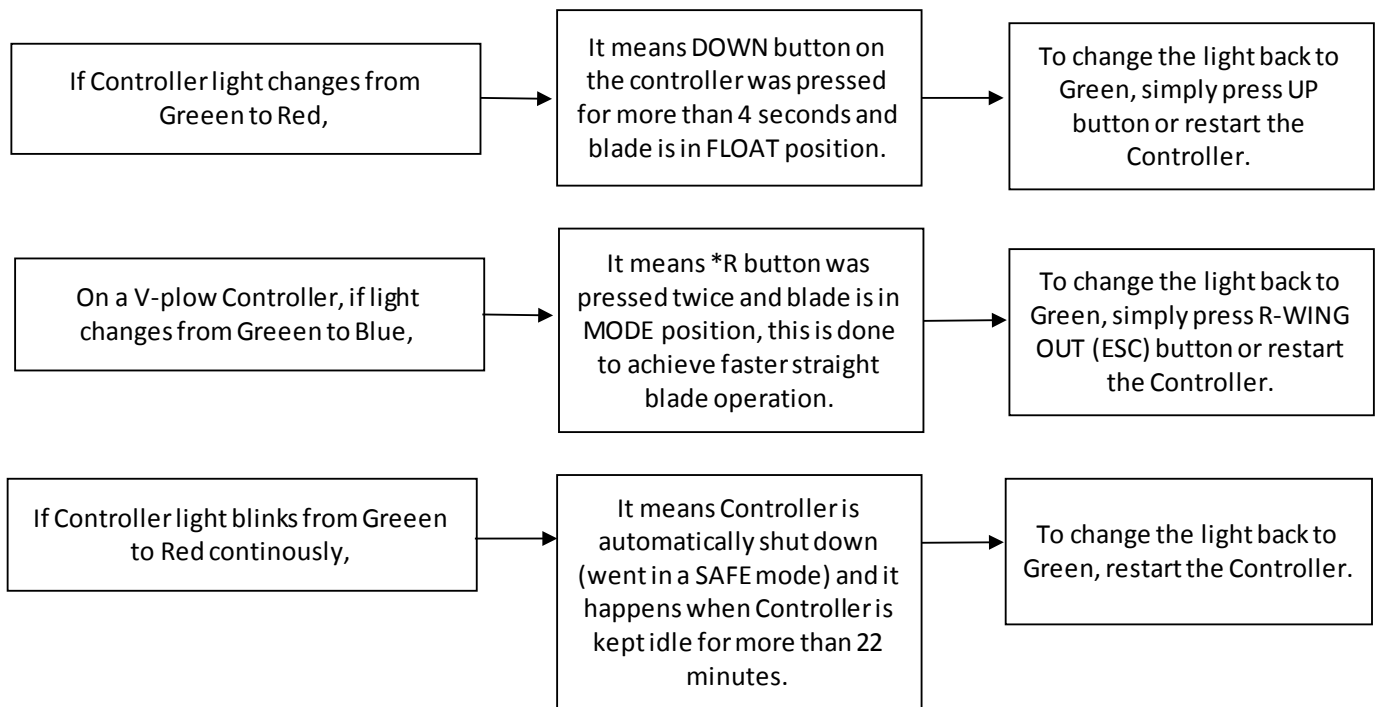

Restart truck's ignition after every step of troubleshooting.

Click on the link <https://www.youtube.com/watch?v=gKqEarX4FrQ> to watch the video of this specific troubleshooting step.



## Connectors alignment for the MPX system

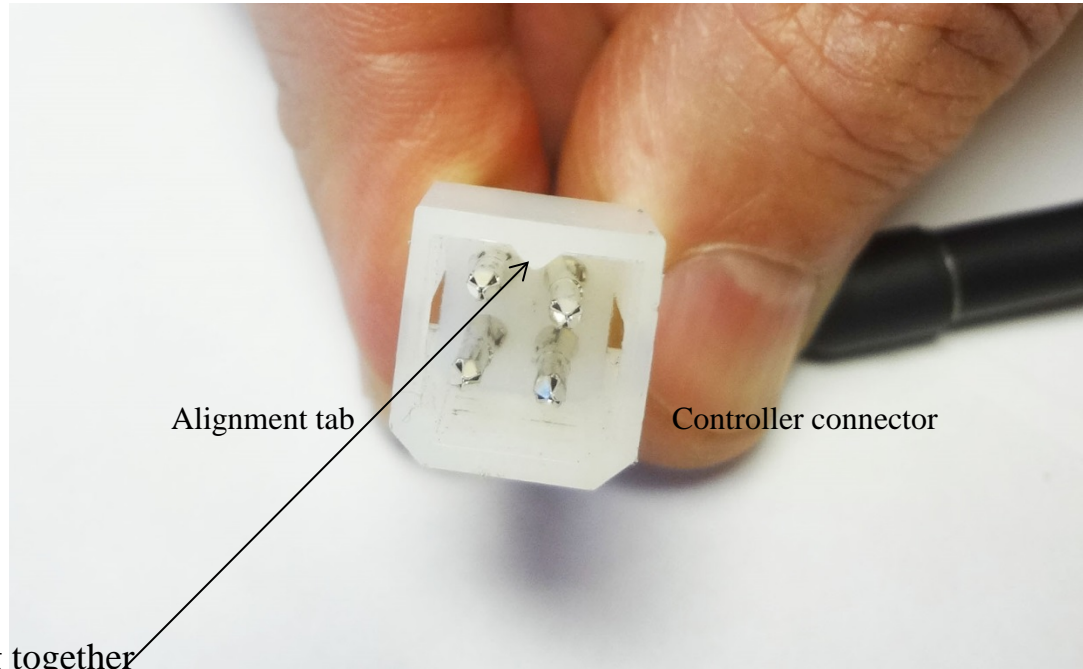

Must align before plugging together

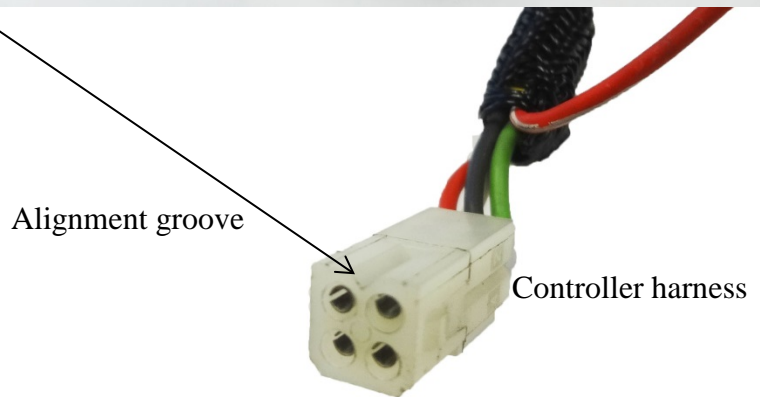

## Tool for updating MPX module box (53707-N)



Check the link below to see step by step procedure on how to update the module box on your truck:

<https://www.youtube.com/watch?v=nGSTAm8hZ9Y>