

MPX troubleshooting flowchart

(Except Dodge 2500/3500/4500/5500)

Front Installation

(module installed in the front)

For troubleshooting on Dodge trucks

Click here

Important Note:

- Use **Power Probe III** tool to troubleshoot the MPX system.
- <https://www.youtube.com/watch?v=FuzfCO1A1Vw> – Link for Power Probe III tool instructions
- Update the modular box by updating tool (53707-N) if it was installed before 2017.
- See last page for more information on updating the modular box.

Controller Harness (Male Pins)

(FRONT VIEW)

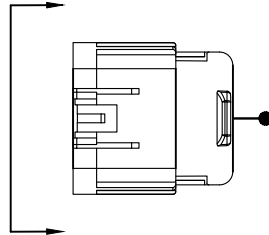

PIN #	COLOR	FUNCTION
A	RED	POS (+) to RING
B	BLACK	GROUND
C	BROWN	PUMP (SOLENOID)
D	CAVITY PLUG	-
E	CAVITY PLUG	-
F	CAVITY PLUG	-
G	CAVITY PLUG	-
H	CAVITY PLUG	-
J	CAVITY PLUG	-
K	WHITE	CONTROLLER SIGNAL
L	GREEN	CONTROLLER SIGNAL
M	RED/WHITE	POS (+) SWITCHED POWER (COMING FROM IGNITION SOURCE)

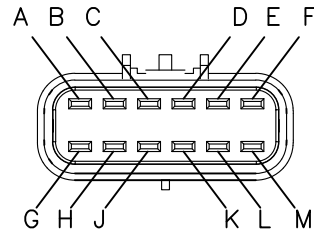

PIN FACE
(FRONT VIEW)

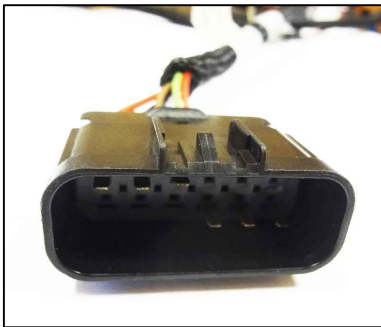

Plug A

Light Harness (Female Pins)

(FRONT VIEW)

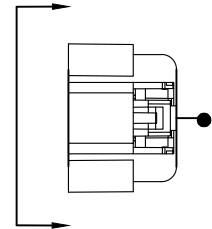

PIN #	COLOR	FUNCTION
A	RED	POS (+) to RING
B	BLACK	GROUND
C	GREEN/YELLOW	TRIGGER
D	YELLOW/RED	DRIVERS SIDE HIGH BEAM
E	GREEN/RED	DRIVERS SIDE LOW BEAM
F	WHITE/RED	COMMON
G	VIOLET	DRIVERS SIDE TURN
H	PINK	CURB SIDE TURN
J	GREY	RUN/PARK
K	CAVITY PLUG	-
L	CAVITY PLUG	-
M	CAVITY PLUG	-

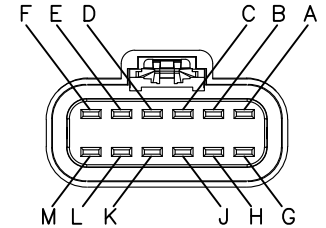

PIN FACE
(FRONT VIEW)



53708-02-N
Insert this pin into Plug B for testing
12V using Power Probe III tool



Plug B

Click on the link below to refer to the specific troubleshooting step:

- Marker/Position light on one side of plow headlights is not working.
- Marker/Position lights on both the sides of plow headlights are not working
- High beam / Low beam on one side of the plow headlights is not working.
- High beam on both the sides of plow headlights are not working.
- Low beam on both the sides of plow headlights are not working.
- Turn Signal on Driver side of the plow headlight is not working.
- Turn Signal on Curb side of the plow headlight is not working.
- Plow does not operate and lights on the plow are not working.
- Plow does not operate.
- Lights do not transfer to the plow.
- Lights on the truck and the plow work at the same time.
- Individual functions on the plow are not working.
- Controller lights keep on changing.

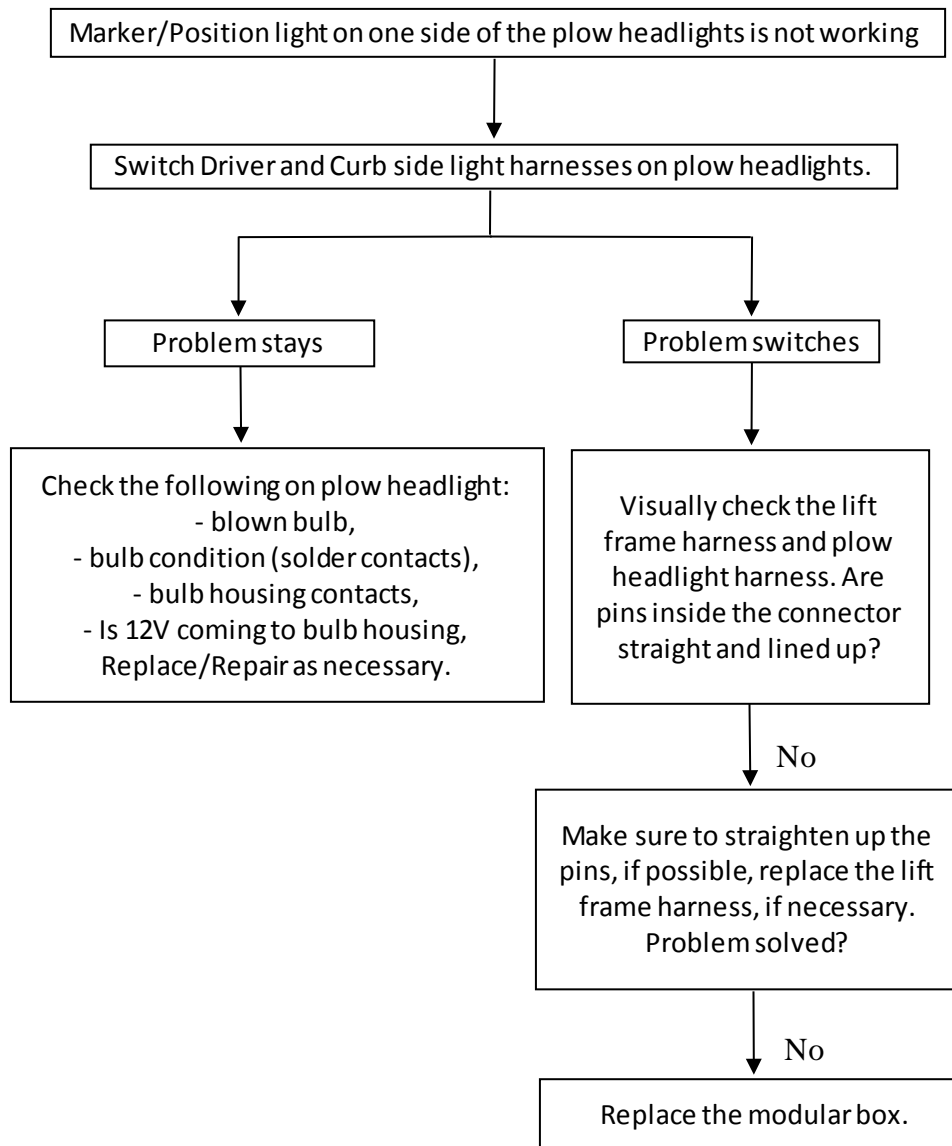

Restart truck's ignition after every step of troubleshooting.

Click on the link https://www.youtube.com/watch?v=NwhY_zgbx6A to watch the video of this specific troubleshooting step.

Link for 800084 headlights: <https://www.youtube.com/watch?v=LJlgbdwop8Q>

Link for 800085 headlights: <https://www.youtube.com/watch?v=fn09WLSG-vI>

Link for 800086 headlights: <https://www.youtube.com/watch?v=sA7AxDIYgwc>

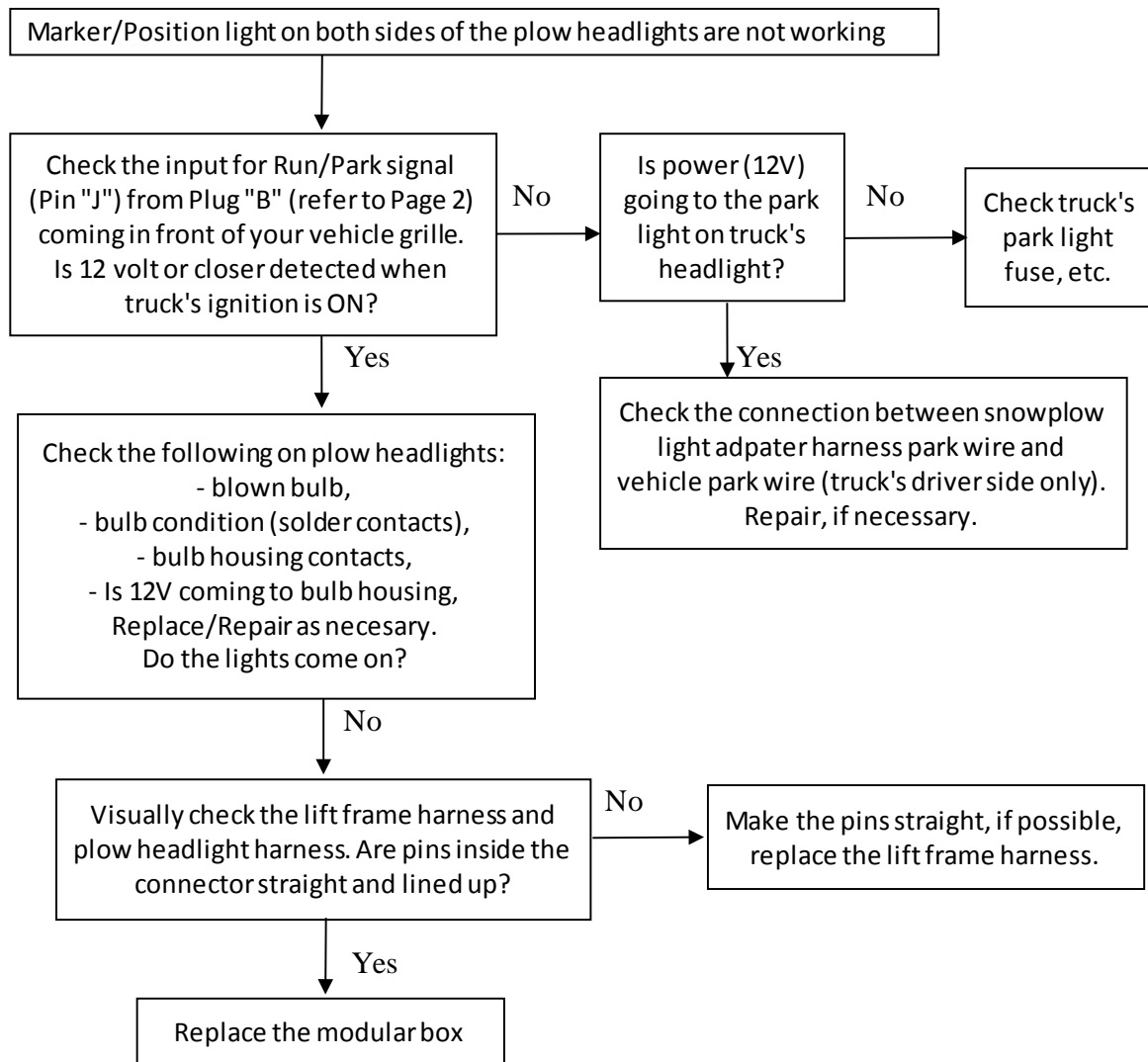

Restart truck's ignition after every step of troubleshooting.

Click on the link <https://www.youtube.com/watch?v=u7a5Dg LHmiU> to watch the video of this specific troubleshooting step.

Link for 800084 headlights: <https://www.youtube.com/watch?v=LJlgbdwop8Q>

Link for 800085 headlights: <https://www.youtube.com/watch?v=fn09WLSG-vI>

Link for 800086 headlights: <https://www.youtube.com/watch?v=sA7AxDIYgwc>

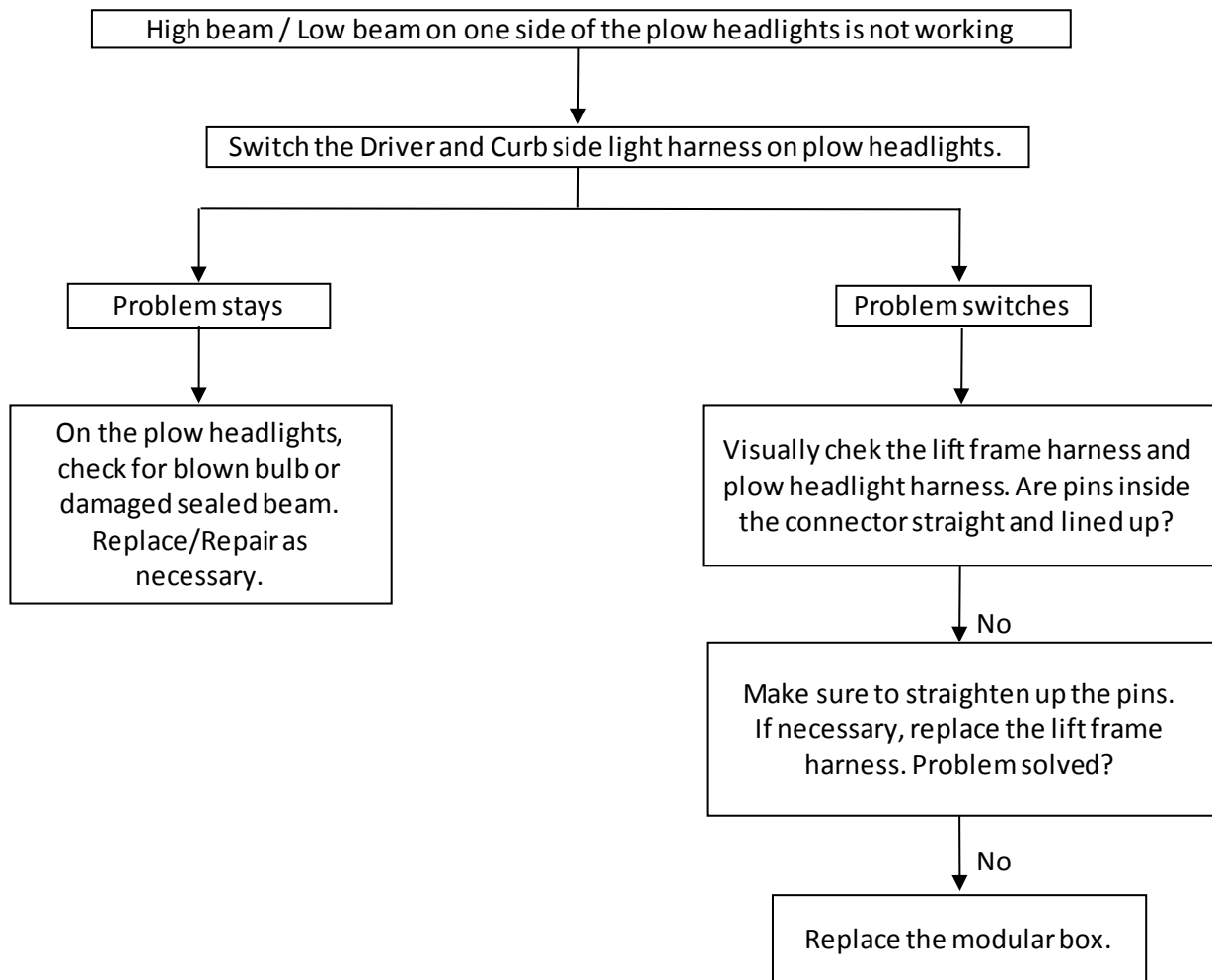

Restart truck's ignition after every step of troubleshooting.

Click on the link <https://www.youtube.com/watch?v=c4yPVrKAKQo> to watch the video of this specific troubleshooting step.

Link for 800084 headlights: <https://www.youtube.com/watch?v=LJlgbdwop8Q>

Link for 800085 headlights: <https://www.youtube.com/watch?v=fn09WLSG-vI>

Link for 800086 headlights: <https://www.youtube.com/watch?v=sA7AxDIYgwc>

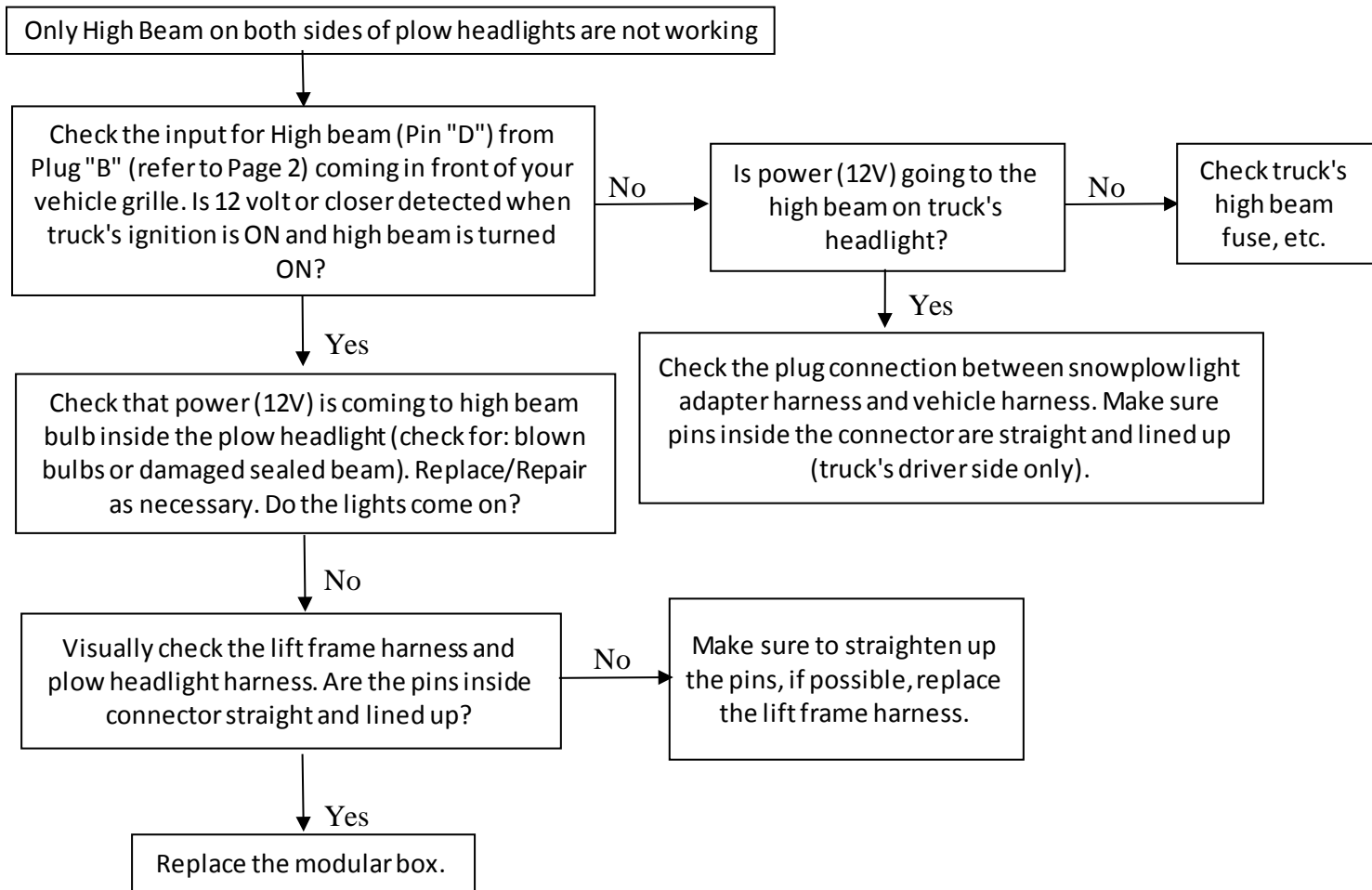

Restart truck's ignition after every step of troubleshooting.

Click on the link <https://www.youtube.com/watch?v=P-pG9PIvAA4> to watch the video of this specific troubleshooting step.

Link for 800084 headlights: <https://www.youtube.com/watch?v=LJlgbdwop8Q>

Link for 800085 headlights: <https://www.youtube.com/watch?v=fn09WLSG-vI>

Link for 800086 headlights: <https://www.youtube.com/watch?v=sA7AxDIYgwc>

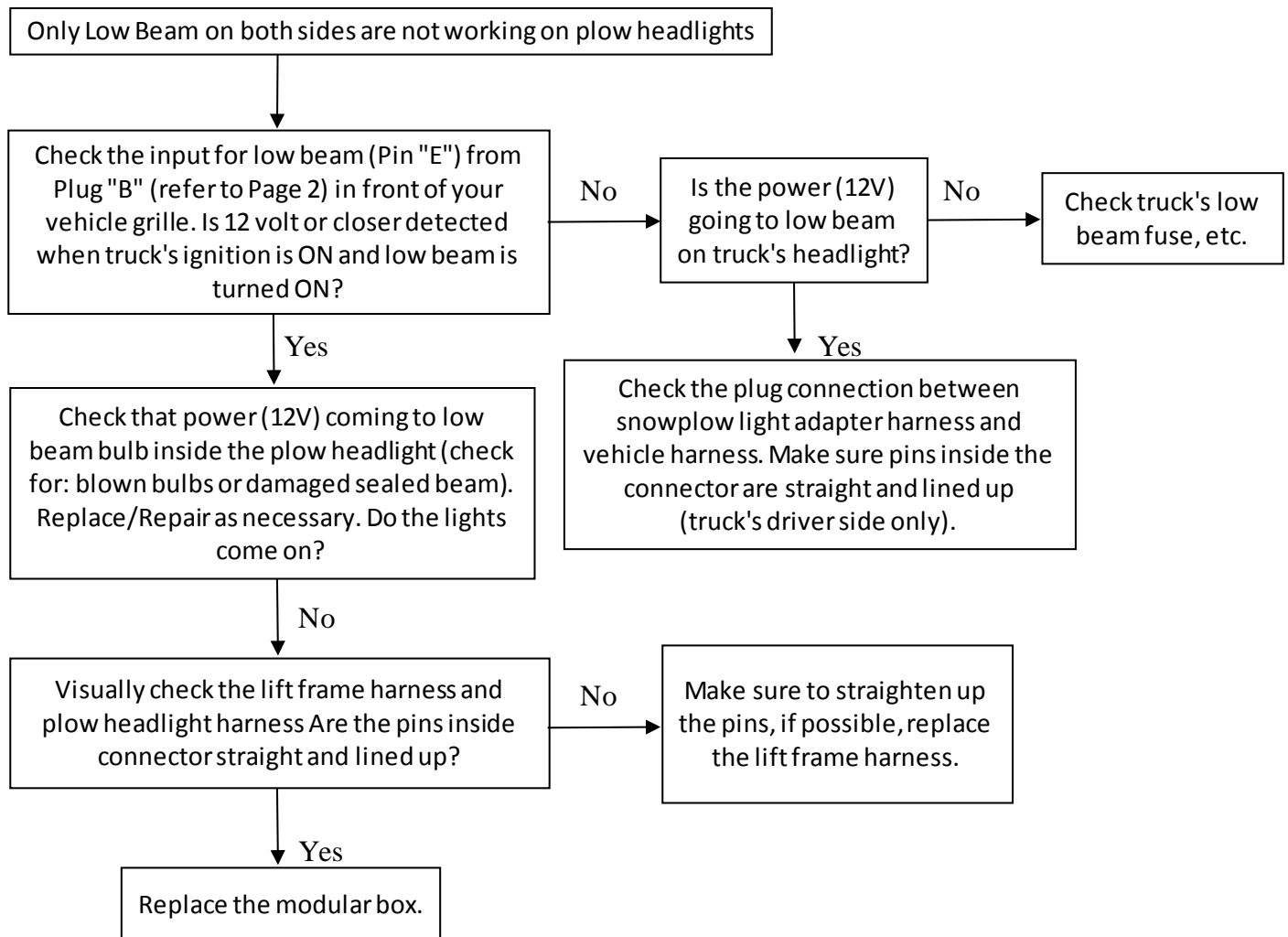

Restart truck's ignition after every step of troubleshooting.

Click on the link <https://www.youtube.com/watch?v=etNSjUYB0Ec> to watch the video of this specific troubleshooting step.

Link for 800084 headlights: <https://www.youtube.com/watch?v=LJlgbdwop8Q>

Link for 800085 headlights: <https://www.youtube.com/watch?v=fn09WLSG-vI>

Link for 800086 headlights: <https://www.youtube.com/watch?v=sA7AxDIYgwc>

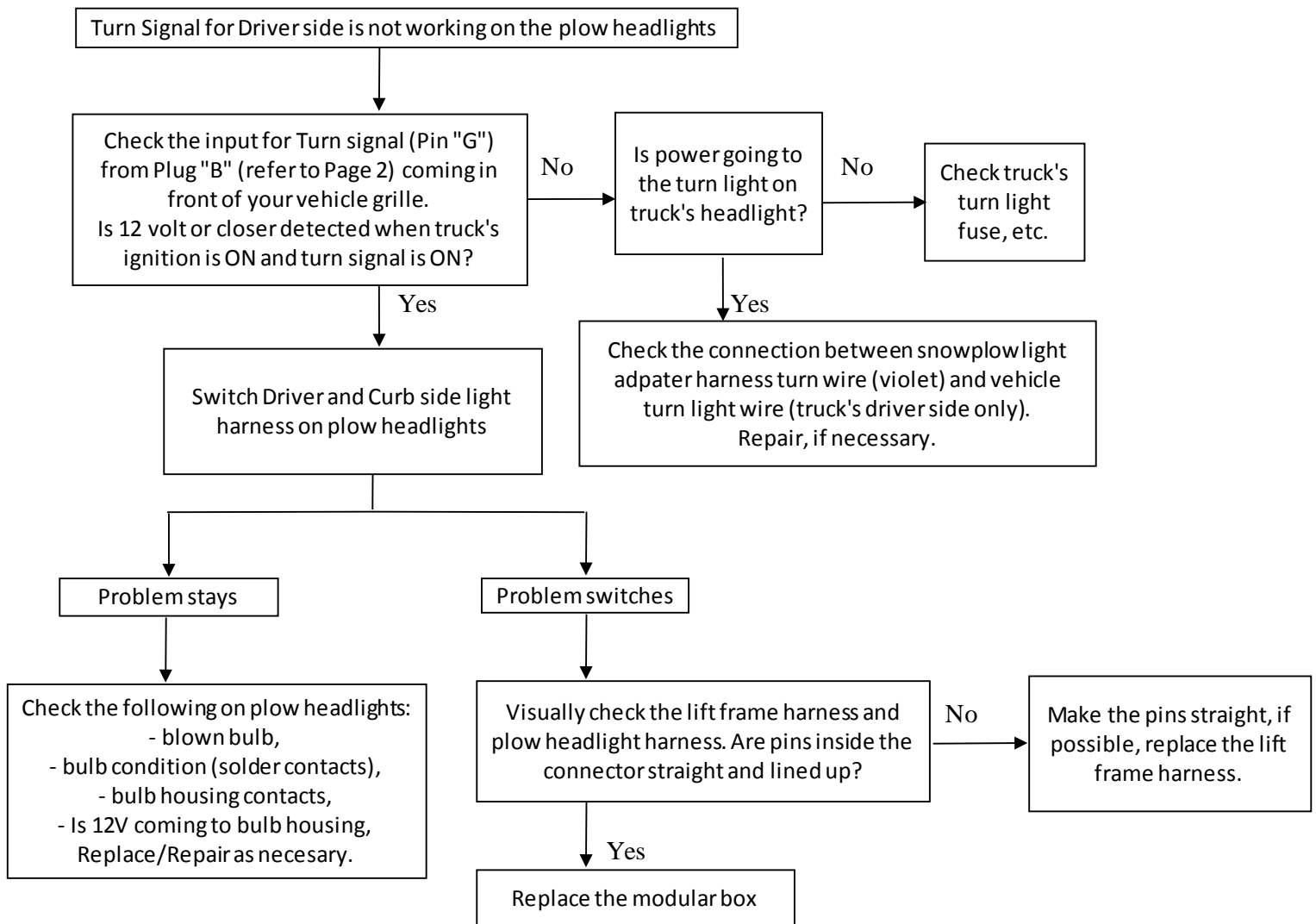

Restart truck's ignition after every step of troubleshooting.

Click on the link <https://www.youtube.com/watch?v=V92YWwG10KI> to watch the video of this specific troubleshooting step.

Link for 800084 headlights: <https://www.youtube.com/watch?v=LJlgbdwop8Q>

Link for 800085 headlights: <https://www.youtube.com/watch?v=fn09WLSG-vI>

Link for 800086 headlights: <https://www.youtube.com/watch?v=sA7AxDIYgwc>

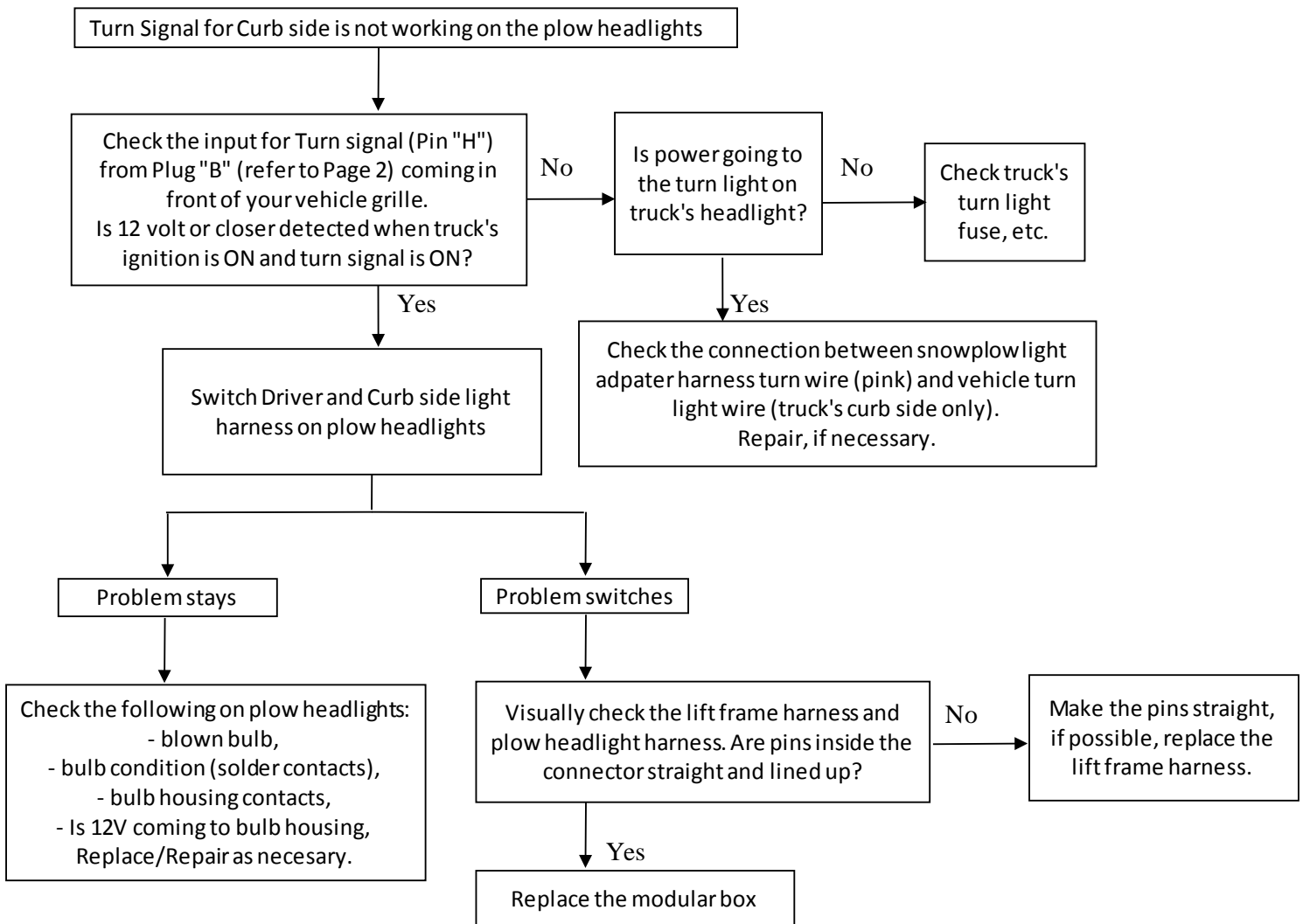

Restart truck's ignition after every step of troubleshooting.

Click on the link <https://www.youtube.com/watch?v=ZZ1qNz3hqzE> to watch the video of this specific troubleshooting step.

Link for 800084 headlights: <https://www.youtube.com/watch?v=LJlgbdwop8Q>

Link for 800085 headlights: <https://www.youtube.com/watch?v=fn09WLSG-vI>

Link for 800086 headlights: <https://www.youtube.com/watch?v=sA7AxDIYgwc>

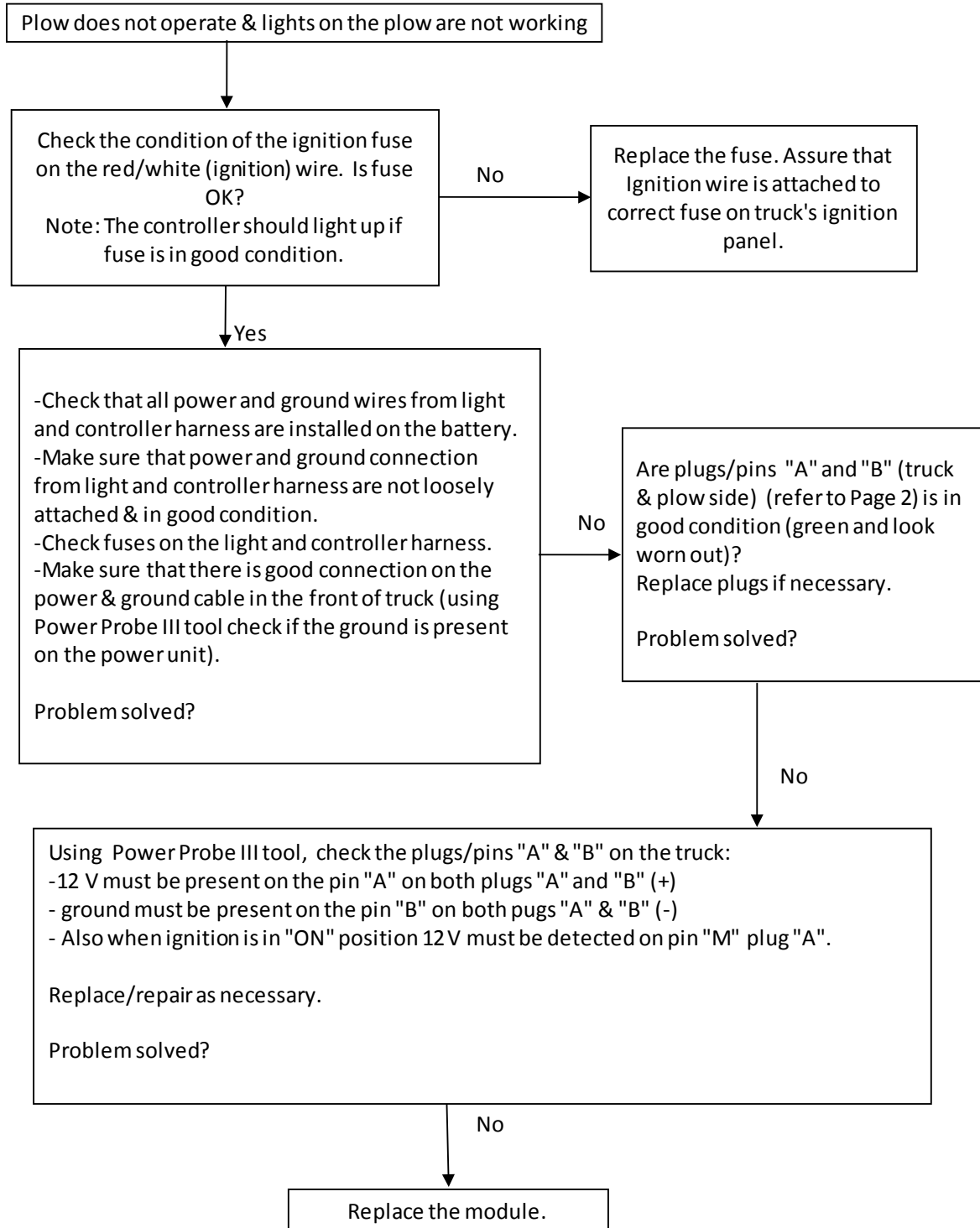

Restart truck's ignition after every step of troubleshooting.

Click on the link <https://www.youtube.com/watch?v=7Xb6IqrcroE> to watch the video of this specific troubleshooting step.

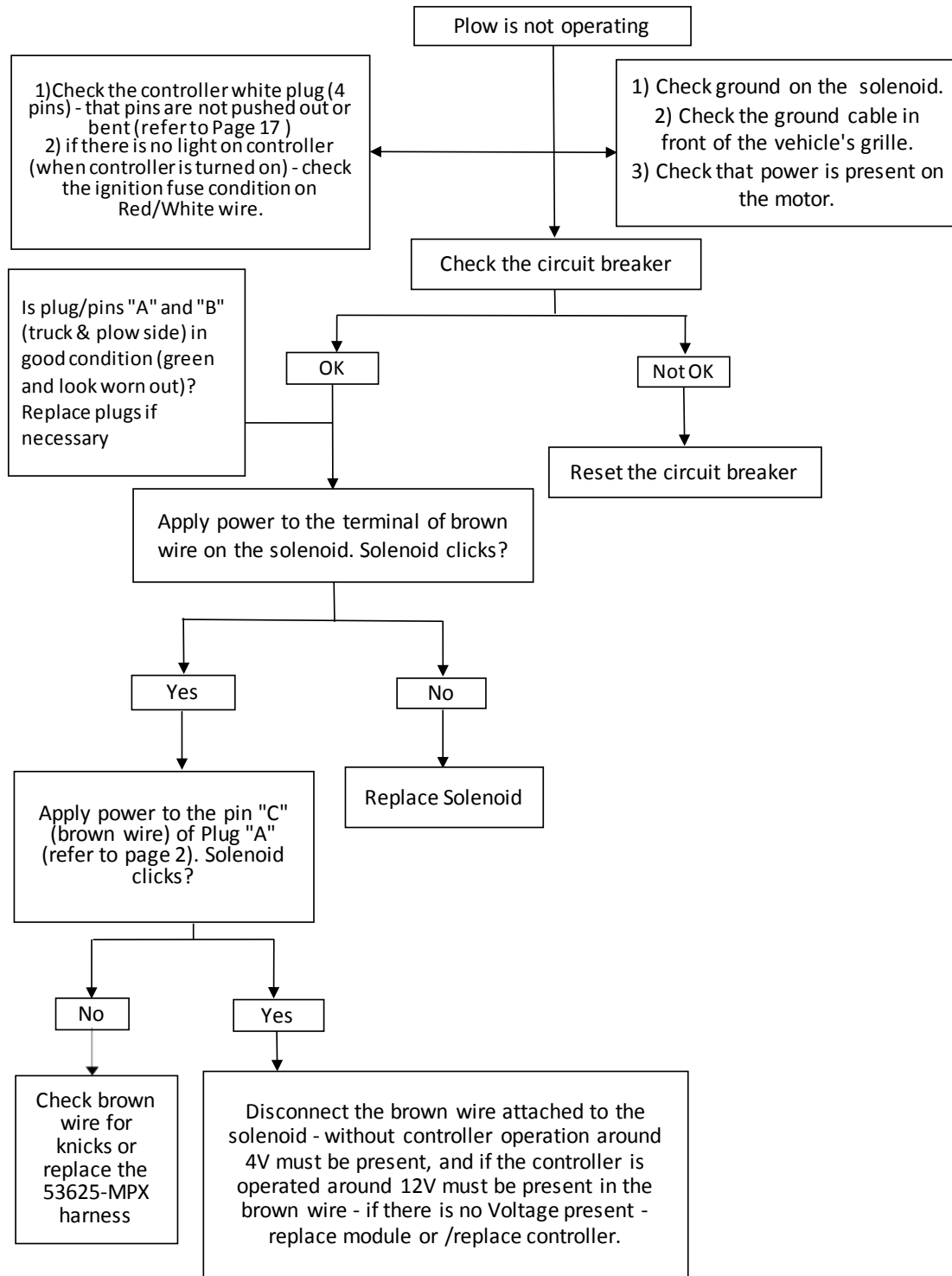

Restart truck's ignition after every step of troubleshooting.

Click on the link <https://www.youtube.com/watch?v=VFVqe-yPWjU&feature=youtu.be> to watch the video of this specific troubleshooting step.

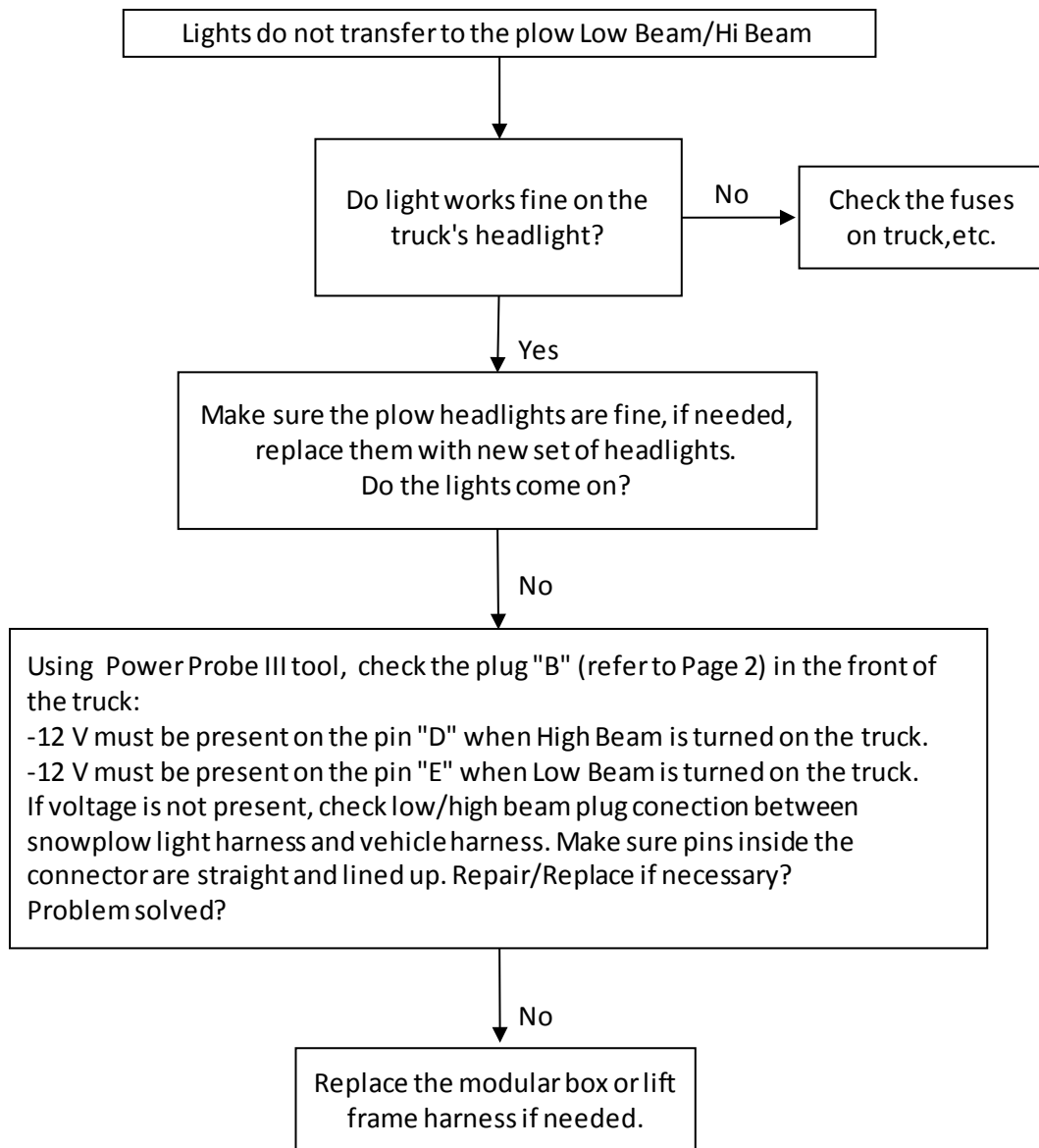

Restart truck's ignition after every step of troubleshooting

Click on the link <https://www.youtube.com/watch?v=P-pG9PIvAA4> and <https://www.youtube.com/watch?v=etNSjUYB0Ec> to watch the video of this specific troubleshooting step.

Link for 800084 headlights: <https://www.youtube.com/watch?v=LJlgbdwop8Q>

Link for 800085 headlights: <https://www.youtube.com/watch?v=fn09WLSG-vI>

Link for 800086 headlights: <https://www.youtube.com/watch?v=sA7AxDIYgwc>

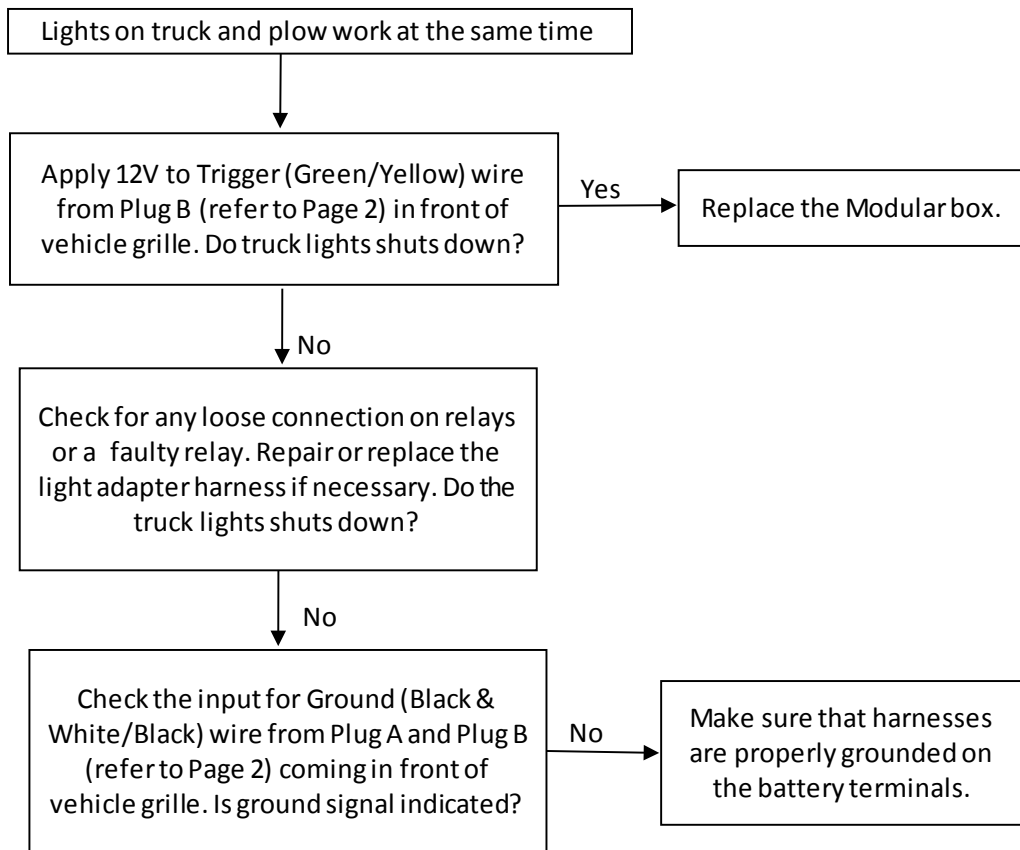

Restart truck's ignition after every step of troubleshooting.

Click on the link <https://www.youtube.com/watch?v=EhCBVoH8dac> to watch the video of this specific troubleshooting step.

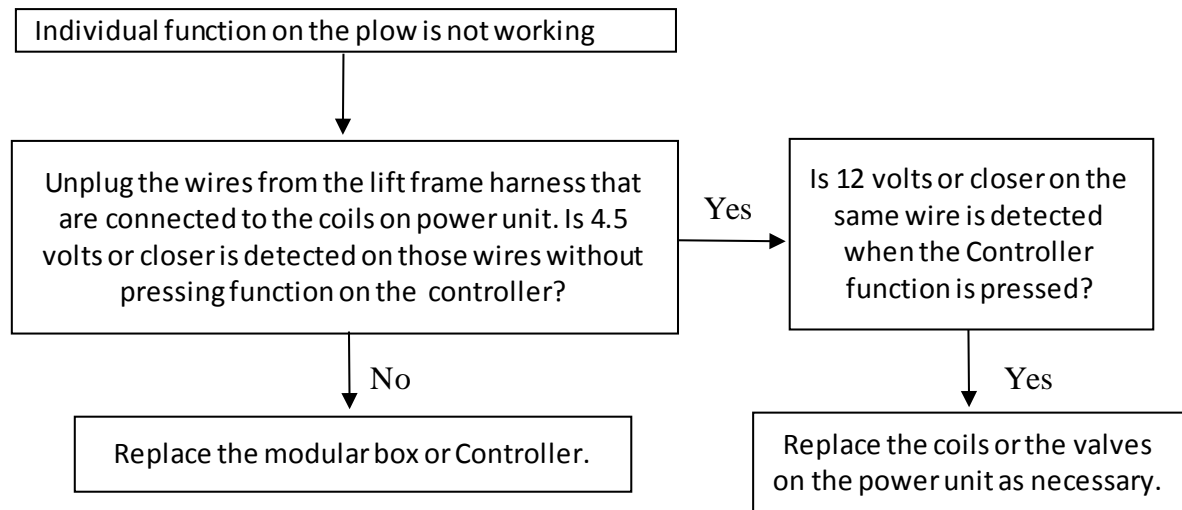

Restart truck's ignition after every step of troubleshooting.

Click on the link <https://www.youtube.com/watch?v=K1ERrFWnUw0> to watch the video of this specific troubleshooting step.

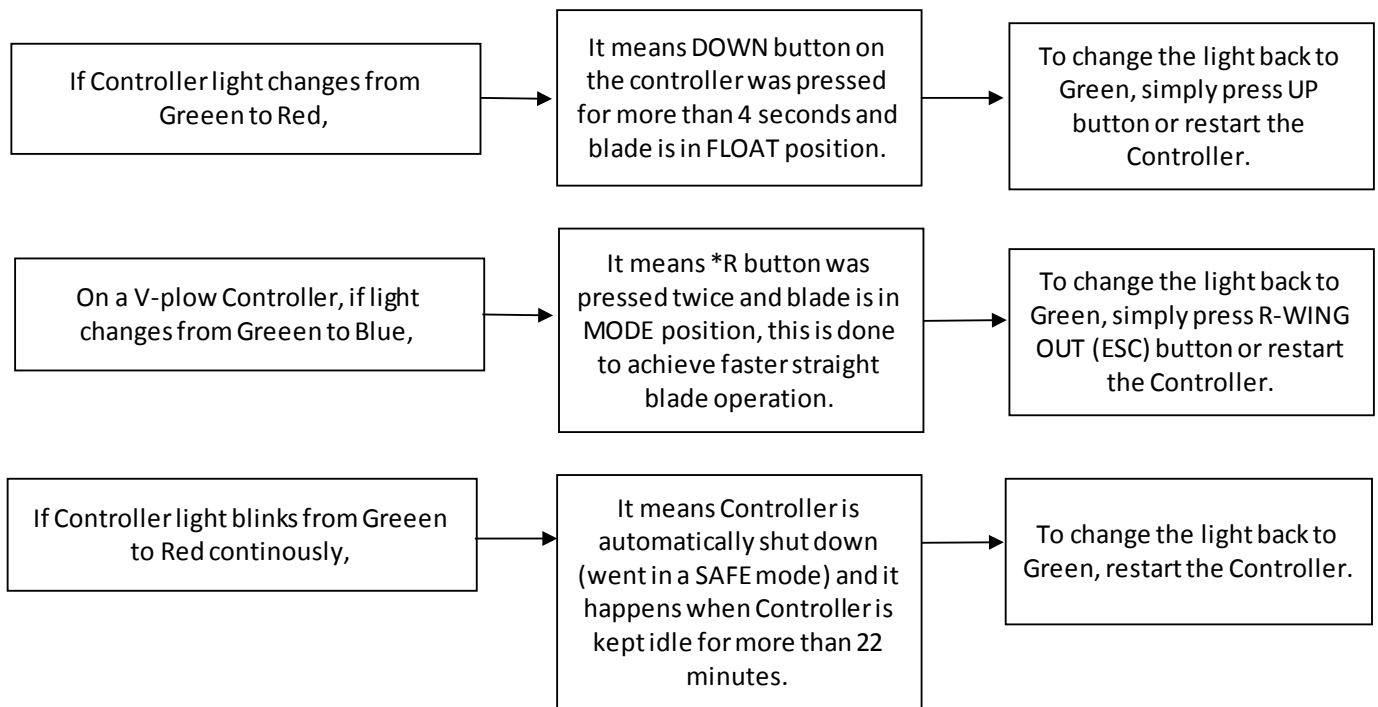

Restart truck's ignition after every step of troubleshooting.

Click on the link <https://www.youtube.com/watch?v=gKqEarX4FrQ> to watch the video of this specific troubleshooting step.

Connectors alignment for the MPX system

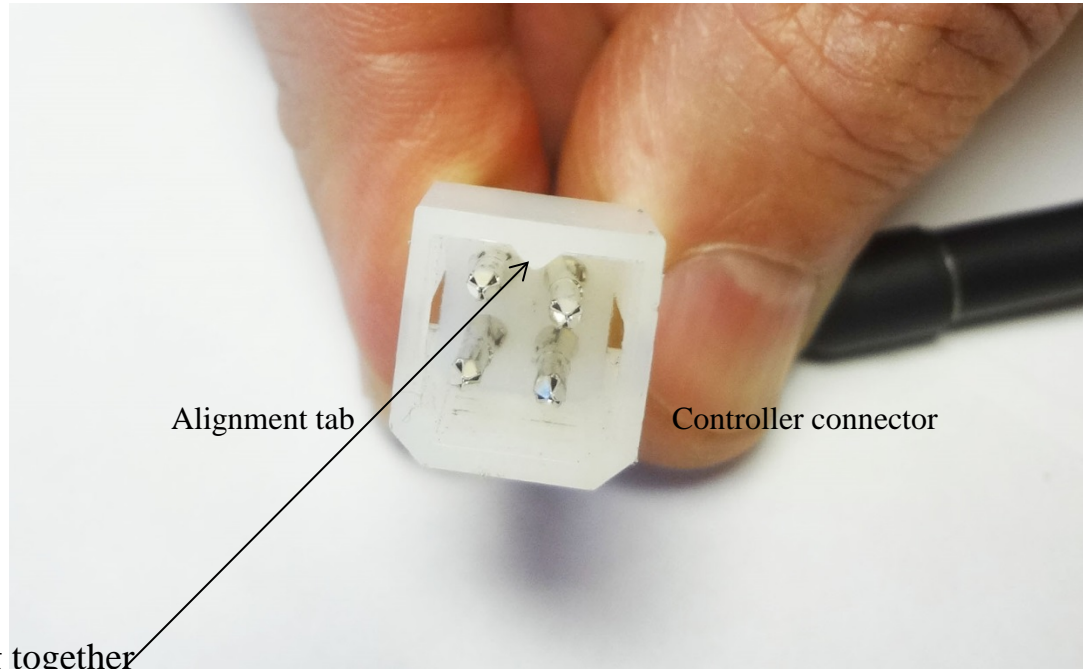

Must align before plugging together

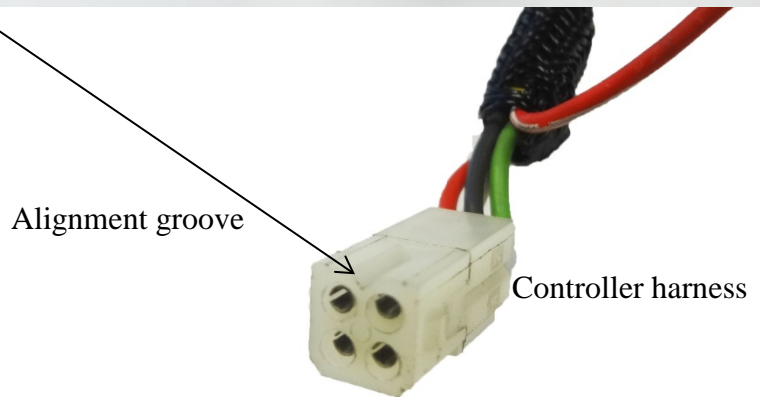

Tool for updating MPX module box (53707-N)



Check the link below to see step by step procedure on how to update the module box on your truck:

<https://www.youtube.com/watch?v=nGSTAm8hZ9Y>