

Mounting Kit 53278-MKPB-QLIV

Toyota Tundra (2007-2016)

For snowplow lights (2007-2013), this kit requires:

800084, 800085 or 800086 Light kit,

53617-M wiring kit, 800042 light adapter kit vehicle's bulb H9005 (HB3) and H11).

Snowplow lights (2014 – 2016), this kit requires:

800084 or 800085 or 800086 Light kit,

800082-MPX for Front Installation.

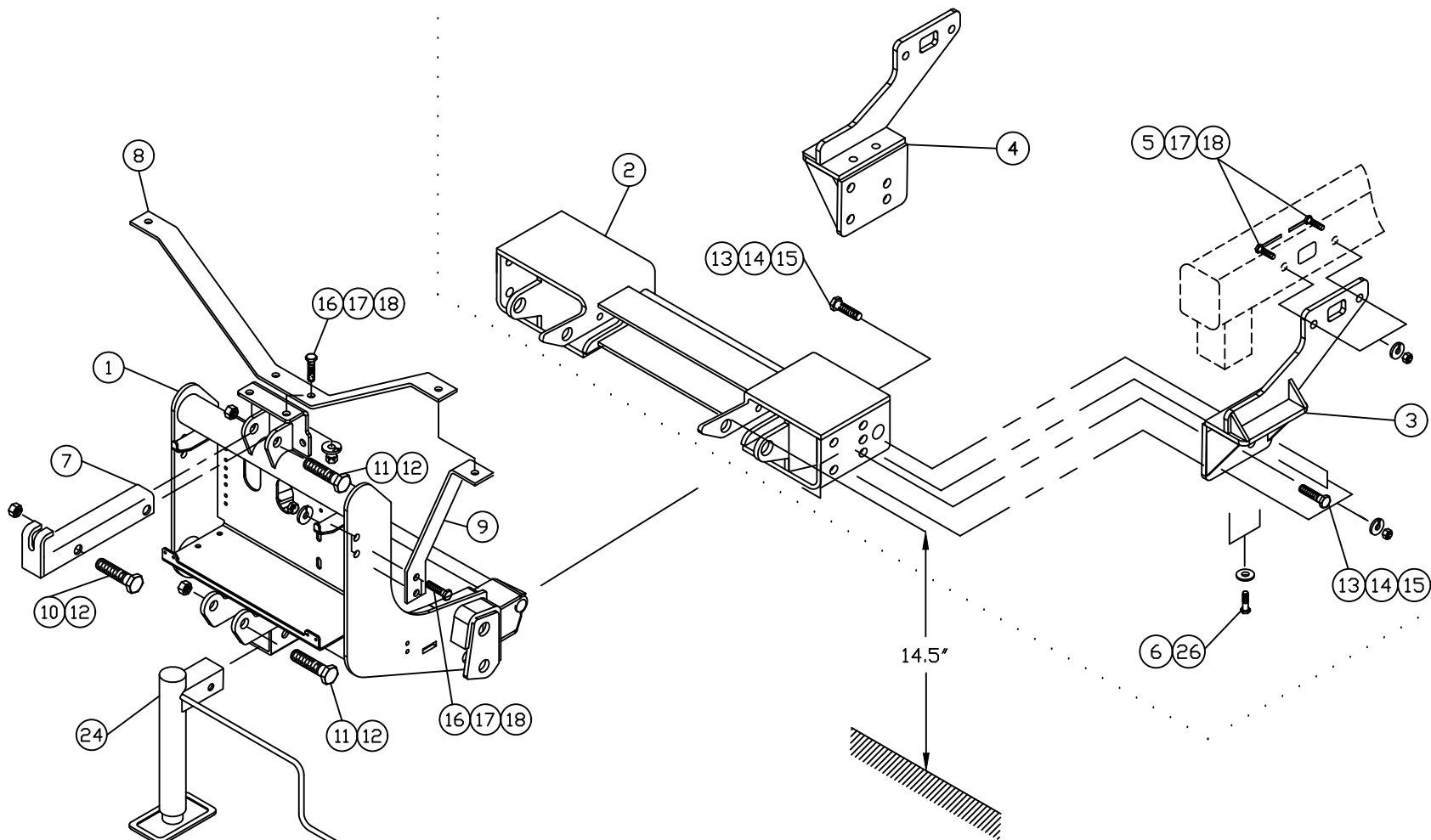

Note:
 1. MKPB is shown by dotted lines.
 2. All bolts are included in MKPB
 3. Please use LOCTITE®, or similar locking product on ALL mounting hardware (bolts, nuts, etc.).

Item	Part #	Description	Quantity
1a*	53170-D-GA	Lift Frame, QUIK*LINK ® II- low mount	1
1b*	53171-D-GA	Lift Frame, QUIK*LINK ® II- Hi boy	1
1	53564-D	Lift Frame, QUIK*LINK ® II- low mount	1
1d*	53517-D	Lift Frame, QUIK*LINK ® IV- Hi boy	1
2	53507-C	Spreader Bar QLIV	1
2a*	52364-C	Spreader Bar QLII	1
3	53283-01-A	Mounting Bracket DS	1
4	53283-02-A	Mounting Bracket CS	1
5	52575-A	Welded Bolt	4
6	HH-00931-056	M12 x 1.25 x 40 mm bolt	4
7	50069-C-GA	Lift Channel Galvanized	1
8	52209-B-GA	Light Antler Galvanized	1
9	52208-B-GA	Light Brace Galvanized	1
10	HH-00972-149	3/4" x 2½" UNF Cap screw	1
11	HH-00972-153	3/4" x 3½" UNF Cap screw	2
12	HH-00973-007	3/4" UNF Thin Collar Locknut	3
13	HH-00972-129	5/8" x 1 3/4" UNF Cap screw	8
14	HH-00457-003	5/8" Lock washer	8
15	HH-00460-001	5/8" UNF Hex nut	8
16	HH-00972-090	½" x 1½" UNF Cap screw	6
17	HH-00457-001	½" Lock washer	10
18	HH-00460-002	½" Hex nut	10
19*	HH-00293-006	1/4" x 1" Cap screw	4
20*	HH-00457-006	1/4" Lock washer	4
21*	HH-00341-002	1/4" Flat washer	4

Item	Part #	Description	Quantity
22*	HH-00294-001	1/4" Hex nut	4
23*	52348-M	Mounting Pin Ass'y	2
24	52373-M	Jack Assembly	1
25*	50999-B	Blade guides	2
26	HH-00932-004	12 mm flat washer	4

QUIK*LINK is a trademark of Arctic Equipment Manufacturing Corporation

Note: * These items are not shown on the drawing.

GENERAL

Customer must be aware of following:

Arctic Equipment Manufacturing Corporation (Arctic) does not assume liability for damage to your motor vehicle resulting from the attachment or use of an Arctic snowplow. The purchaser assumes all vehicle risk associated with the attachment and operation of this snowplow.

The Arctic snowplow you purchase must be used only on vehicles equipped with the manufacturer's snow plow preparation package. Snow plowing without the original plow preparation package may damage your vehicle. The added weight may impair the operation and control of your vehicle. Snow plowing with a vehicle not recommended for that purpose by the manufacturer may void your new vehicle warranty. If your vehicle is not equipped with an original snow plow preparation package, additional equipment may be necessary before snow plowing. Please consult your vehicle and snowplow dealers prior to the purchase and installation of the snowplow. The installation of such parts however is not a full substitute for the original equipment snowplow preparation package. Before drilling any holes in the firewall or frame, move brake lines, fuel lines and/or electrical wiring from the path of the drill. Brake and fuel lines must also be clear of any fasteners.

All bolts should be installed from the inside of the truck frame so that the lock washers and nuts are accessible for re-tightening.

If a slotted hole in the truck frame is utilized, then a flat washer must be used under the bolt head. If a flat washer is used under a lock washer use LOCTITE #242. Also use this LOCTITE #242 if existing (vehicle) bolts and nuts are used.

Do not tighten any bolt assemblies until all fasteners and components are installed, unless otherwise specified.

After first use, re-tighten all mounting bolts, thereafter check mounting bolt tightness periodically.

Before proceeding, read instructions carefully and familiarize yourself with the components and hardware.

INSTALLATION INSTRUCTIONS

1. Remove splash pan. (See: picture below) Remove tow hooks.
2. Install mounting brackets (3)(4) using M12 mm bolts(6) (apply LOCTITE #242 on the bolts) and 12 mm flat washer (26).
3. Drill 17/32" hole through the side of vehicle frame using hole in the mounting bracket (3) (4) as guide. Insert two 1/2" bolts with welded bar (5) through holes on the side of the vehicle frame and secure with 1/2" lock washer (17) and 1/2" nut (18).
4. Insert the spreader bar (2) between two mounting brackets (3)(4). The spreader pin hole should be located 14 1/2" (+/- 1/2") off of the ground. Insert 5/8" x 1 3/4" bolts (13) from inside of spreader bar (2) through mounting bracket (3)(4) holes and secure using 5/8" lock washer (14) and 5/8" nut (15). (Note: Only one 5/8" (13) bolt needs to be installed from outside - see drawing)
5. Torque all fasteners according to torque chart.
6. Slide lift frame (1) inside of spreader bar (2). Insert mounting pin (23) in the top holes of the spreader bar (2).
7. Install light antler (8) and light braces (9) using 1/2" x 1 1/2" bolts (16), 1/2" lock washers (17) and 1/2" hex nuts (18). Install lights so that the light mounting stud goes through both antler (8) and the brace (9). Tighten all light mounting hardware.
8. Install lift channel (7) and front mount pump (from hydraulic kit) or hydraulic cylinder to lift frame (1) using 3/4" x 3 1/2" bolts (11) and 3/4" locknuts (12). Use 3/4" x 2 1/2" bolts (10) and 3/4" locknuts (12) to attach lift channel (7) to front mount pump or hydraulic cylinder. Do not over tighten this assembly as it must be able to pivot.
9. Use 1/4"x 1" bolt (19), 1/4" flat washer (21), 1/4" lock washer (20) and 1/4" hex nut (22) to fasten blade guides (25) to plow.
10. Return any unused items to the customer so that the vehicle can be returned to its original condition if the snowplow is removed.
14. See separate installation instructions for the hydraulic power unit, wiring and controls.



Suggested torque value for bolts				
Thread Size	Grade 5		Grade 8	
	Dry (ft. lb)	Oiled (ft.lb)	Dry (ft. lb)	Oiled (ft.lb)
¼-20	8	6	12	9
¼-28	10	7	14	11
5/16-18	17	13	24	18
5/16-24	19	15	27	21
3/8-16	31	24	44	34
3/8-24	35	27	49	38
7/16-14	49	38	70	54
7/16-20	55	42	78	60
½-13	75	58	105	82
½-20	85	65	120	90
5/8-11	150	115	210	165
5/8-18	170	130	240	185
¾-10	270	205	375	290
¾-16	295	230	420	320
7/8-9	395	305	605	455
7/8-14	435	335	670	515
1-8	590	455	905	695
1-14	660	510	1030	785

For 2014-2016 Toyota Tundra modify (cut) the connector (the light adapter 800082-MPX or 800082-MPX-1) as shown on the pictures.

